



www.vortice.com



VORT NRG RANGE
COMMERCIAL VENTILATION

NEW



HEADQUARTERS

VORTICE IN THE WORLD



Our current Vortice Headquarters have been located in Tribiano (Milan) since 1972.

Vortice main company's philosophy is the concept that "air is our life". Our mission is always to provide effective solutions for improved air quality using the latest technology to develop and manufacture effective products worldwide.

Vortice has achieved European market leadership by dedicating their efforts to the production of products for ventilation, climate control, heating, extraction, purification and the treatment of air, for domestic, commercial and industrial applications. Since 1954 Vortice has been synonymous with quality and excellence and continues to make significant improvements by investing in continuous research to improve the efficiency and quality of its products.



Founded in 1974, Vortice France is located at Crétail about 10 Km from Paris.



Founded in 1977, Vortice Limited is located at Burton on Trent in the East Midlands.



Founded in 2012, Vortice Ventilation System is located about 200 Km from Shanghai.



Founded in 2012, Vortice Latam in San José Costa Rica.

INDEX

COMMERCIAL VENTILATION

04 VORT NRG EC RANGE

Heat recovery units equipped with **static heat exchangers** characterized by high levels of heat exchange efficiency, top performances consumptions.

32 VORT NRG ECR RANGE

Heat recovery units equipped with **rotary heat exchangers** characterized by high levels of heat exchange efficiency, top performances and low consumptions, especially suitable for applications typified by low outdoor temperatures and limited installation space.

*“For many years now, the theme of the strategy that has guided policy in the selection and development of new **VORTICE** products has been one of researching and implementing solutions aimed at achieving the most effective balance between high performance, low energy consumption, minimal noise levels and reasonable purchase and running costs.*

*This approach, in accordance with the most recent **EU Directives** and **Regulations** designed to promote the integration of environmental aspects into the design of appliances, is reflected in the range of new **VORTICE** products presented here.”*

Regulations and Standards

Machinery Directive Standards

EN 60204-1
EN 12100
EN 12499
EN 13857
EN 1886
EN 13053+A1

EMC standards

EN 55014-1
EN 55014-2
EN 61000-3-2
EN 61000-3-3

European Directives and Regulations pertinent to CE marking.

Machinery Directive: N° 2006/42/EC
EMC Directive: N° 2004/108/EC
Energy Related Products (ErP) Directive: N° 2009/125/EC
Electric Motor Efficiency Regulation: N° 640/2009/EC
Motor-fans Regulation: N° 327/2011/UE
Ventilation Units Regulation: N° 1253/2014/UE

LEGEND:



The ErP compliant logo indicates that the appliance is eco-compatible and adheres to ErP Directive 2009/125/EC.



VORT NRG EC RANGE

Heat recovery units equipped with static heat exchangers characterized by high levels of heat exchange efficiency, top performances consumptions



COMPOSITION OF THE RANGE

The NEW RANGE of **VORT NRG EC** heat recovery units is made up of 9 models (air flow rates between 100 m³/h and 8000 m³/h), each available in two versions:

VORT NRG EC, suitable for installation in temperate climates.

VORT NRG EC EH, equipped with automatically controlled electric pre-heating coils, suitable for operation with outdoor temperatures down to -20 °C.

The composition of the new **VORT NRG EC** series is indicated below:

Products	Code	Products	Code
VORT NRG 600 EC	45380	VORT NRG 600 EC EH	45390
VORT NRG 800 EC	45381	VORT NRG 800 EC EH	45391
VORT NRG 1500 EC	45382	VORT NRG 1500 EC EH	45392
VORT NRG 2000 EC	45383	VORT NRG 2000 EC EH	45393
VORT NRG 2500 EC	45384	VORT NRG 2500 EC EH	45394
VORT NRG 3000 EC	45385	VORT NRG 3000 EC EH	45395
VORT NRG 4500 EC	45386	VORT NRG 4500 EC EH	45396
VORT NRG 6000 EC	45387	VORT NRG 6000 EC EH	45397
VORT NRG 8000 EC	45387	VORT NRG 8000 EC EH	45398

SPECIAL VERSIONS OF EACH MODEL, AVAILABLE ON REQUEST, INCLUDE:

- advanced electronics, compatible with the management of external devices such as post-heating coils (electric or hydronic), hydronic post-cooling coils and pre-heating coils (**FIRST** versions).
- a hydronic post-heating coil (**PREMIUM BC** versions)
- an electric post-heating coil (**PREMIUM BE** versions)
- a hydronic post-heating coil and a pre-heating coil (**INFINITE BC** versions)
- an electric post-heating coil and a pre-heating coil (**INFINITE BE** versions)
- Constant pressure fan control (**LOBBY** versions)
- Constant flow fan control (**MAC2** versions)
- Automatic modulation of fan speed, between two preset limits, according to the concentration of CO₂ in the connected rooms (**DIVA** versions)
- Automatic modulation of air flow rates of fresh and stale air, between two preset limits that remain constant with variations in back pressure, in response to the concentration of CO₂ in the connected rooms (**QUATTRO** versions)



FEATURES OF CONSTRUCTION

- Cabinet frame fabricated from rounded aluminium profiles; moulded nylon spacers incorporated to provide thermal break; sandwich panels with 10/10 gauge skins (inner: zinc-coated steel; outer: pre-lacquered steel (RAL 7035) with protective film); high density rock wool insulation layer (M0), thickness 25 mm in models 600, 800, 1500, 2000 and 2500, thickness 50 mm in models 3000, 4500, 6000 and 8000.
- 2-speed, ball bearing external rotor EC motors (speeds independently adjustable at installation) directly coupled to backward curved centrifugal impellers, capable of ensuring air flow rates up to 8000 m³/h in conjunction with low noise levels.
- Air-to air, aluminium made, counter-flow heat exchanger, granting Eurovent-certified efficiency better than 90% based on European standard EN 308. The heat exchange efficiency of the new VORT NRG EC appliances meets the most stringent requirements of EU regulation 1253/2014, Tier 2, to be implemented January 2018.
- Circular ports with lip seals guaranteeing airtight flow passage (excluding models 8000).
- 100% internal by-pass, automatically operated.
- Filters, G4 in the stale air extraction duct, F7 in the fresh air supply duct, both installed upstream of internal components to guarantee their protection, mounted on slide ways (for ease of removal), and fitted with lip seals to ensure a completely airtight fit.
- Condition of filters constantly monitored by a differential pressure switch with automatic alert generated when maintenance or replacement is due.
- Dedicated cabinet panels with lock and key closure, providing direct access to filters and internal components.
- Brackets incorporated into the cabinet structure, for anchorage to floors or to fixed/suspended ceilings.
- Internal tray, suitably angled, for collection and drainage of condensate.
- Local switch mounted on the external panel; to shut off the unit in the event of breakdown.
- Installation and initial configuration simplified by plug-and-play design.
- Construction compatible with installation outdoors (models 3000 - 4500 - 6000 - 8000), canopies and rain cowls optional.
- Horizontal installation (models 600 - 800 - 1500 - 2000 - 2500 - 3000 - 4500), Horizontal and vertical installation (models 3000 - 4500), Vertical installation (models 6000 - 8000)
- Built-in electric pre-heaters, automatically controlled (**EH** versions).
- Advanced controls (**EH** version), including wired remote control panels with LCD display, allowing integration into Building Management Systems (protocols supported: Modbus, BacNet, Web TCP-IP).



VORT NRG EC RANGE

Heat recovery units equipped with static heat exchangers characterized by high levels of heat exchange efficiency, top performances consumptions

CONTROLS AND SAFETY DEVICES

- **VORT NRG EC** models are equipped with potentiometers by way of which the speed of the two fans can be independently controlled.
- **VORT NRG EC EH** models incorporate advanced electronics including a wired control box with LCD display, connected by wire (maximum distance 100 m) for models 600, 800, 1500, 2000 and 2500, and built into the casing (enclosure rating IP65) for models 3000, 4500 6000 and 8000, which allows:
 - Independent control of fan speeds
 - Weekly programming of operating mode (control software includes a calendar with public holidays and vacations covered).
 - Check on the condition of filters and indication of the need for maintenance or replacement.
 - Setting of machine emergency response mode in the event of fire; there are 5 different settings provided, selectable at the moment of installation:
 - **“STOP”**: both fans cease operation.
 - **“ON”**: start up or continue operating at maximum speed all other alarms are ignored.
 - **“AUTO”**: the unit continues to operate on the basis of the setting (OFF, low speed, high speed) selected previously.
- **“SUPPLY ONLY”**: the fan on the supply air side is made to run at maximum speed, whilst the fan in the extraction duct is shut down.
- **“EXTRACT ONLY”**: the fan on the stale air extraction side is made to run at maximum speed, whilst the fan in the supply air duct is shut down.
- To enable these operating modes, each **VORT NRG EC EH** heat recovery unit incorporates a digital “external stop” contact allowing the connection of a manual switch: if available and wired up, this switch will always have priority over the fire emergency response operating modes.
- The air flow through each fan is permanently monitored by a dedicated pressure switch; any faults detected are indicated, in the case of **VORT NRG EC EH** versions, on the display of the control panel (in the case of **VORT NRG EC** versions, a voltage free contact is available for the connection of an external indicator device).
- The machine can be shut down in emergencies by means of a local switch, mounted on the cabinet of all models, which is padlockable to prevent unauthorized access.

GENERAL SPECIFICATIONS

Equipmen	VORT NRG EC models	VORT NRG EC EH models
Two speed low energy EC fan unit: speeds independently adjustable	•	•
F7 filter on fresh air supply duct	•	•
G4 filter on stale air extraction duct	•	•
Counter cross-flow heat exchanger delivering high efficiency (>90%), certified by Eurovent	•	•
100% by-pass	•	•
Angled tray for collection and drainage of condensate	•	•
Sandwich panels 25 mm thick, with high density rock wool insulation layer and RAL 7035 finish	(models 600 - 800 - 1500 - 2000 - 2500)	(models 600 - 800 - 1500 - 2000 - 2500)
Sandwich panels 50 mm thick, with high density rock wool insulation layer and RAL 7035 finish	(models 3000 - 4500 - 6000 - 8000)	(models 3000 - 4500 - 6000 - 8000)
Circular connection ports with lip seals	• (not for model 8000)	• (not for model 8000)
Remote wired control panel (up to 100 m), with LCD display	-	(models 600 - 800 - 1500 - 2000 - 2500)
Built-in control panel (IP65) with LCD display	-	(models 3000 - 4500 - 6000 - 8000)
Communication module for integration into BMS (protocols: MODBUS RS485, BACNET TCP/IP and WEB selectable in alternation from menu)	-	•
Minimum and Maximum fan speeds controlled from panel	-	•
Potentiometers for independent setting of fan speed	•	-
Temperature sensor in supply air duct	-	•
Temperature sensor in extraction air duct	-	•
By-pass defrost sensor	•	•
Outdoor temperature sensor	•	•
Pre-heating coil sensor	-	•
Safety thermostat on electric pre-heating coil	-	•
Lockable proximity switch	•	•
Power cable gland	•	•
Functions	VORT NRG EC models	VORT NRG EH models
Defrost via by-pass	•	-
Defrost via combined action of by-pass + modulation of fresh air flow rate + pre-heater	-	•
Automatically controlled electric pre-heating coil	-	•
Automatically controlled 100% internal by-pass (ON/OFF), automatic Summer/Winter selection	•	-
Automatically controlled 100% internal by-pass (0-100% modulating)	-	•
Free-cooling function	•	•
Night-cooling function (extra ventilation)	-	•
Fresh air temperature management	-	•
Return air temperature management	-	•
Weekly clock	-	•
Vacation and public holidays clock	-	•
Differential pressure switch monitoring filter in supply air duct	•	•
Pressure switches monitoring supply and extract air flows	•	•
System response modes in the event of fire (5 options)	-	•
Management of dehumidifier module	-	•
Accessories installable on site	VORT NRG EC models	VORT NRG EH models
Remote wired control panel (up to 100 m), with Touch Screen	-	*
Dehumidifier module	-	*

* Optional not fitted

• Standard equipment

- Not available



VORT NRG EC RANGE

Heat recovery units equipped with static heat exchangers characterized by high levels of heat exchange efficiency, top performances consumptions

DIMENSIONS MODELS 600-800-1500-2000-2500

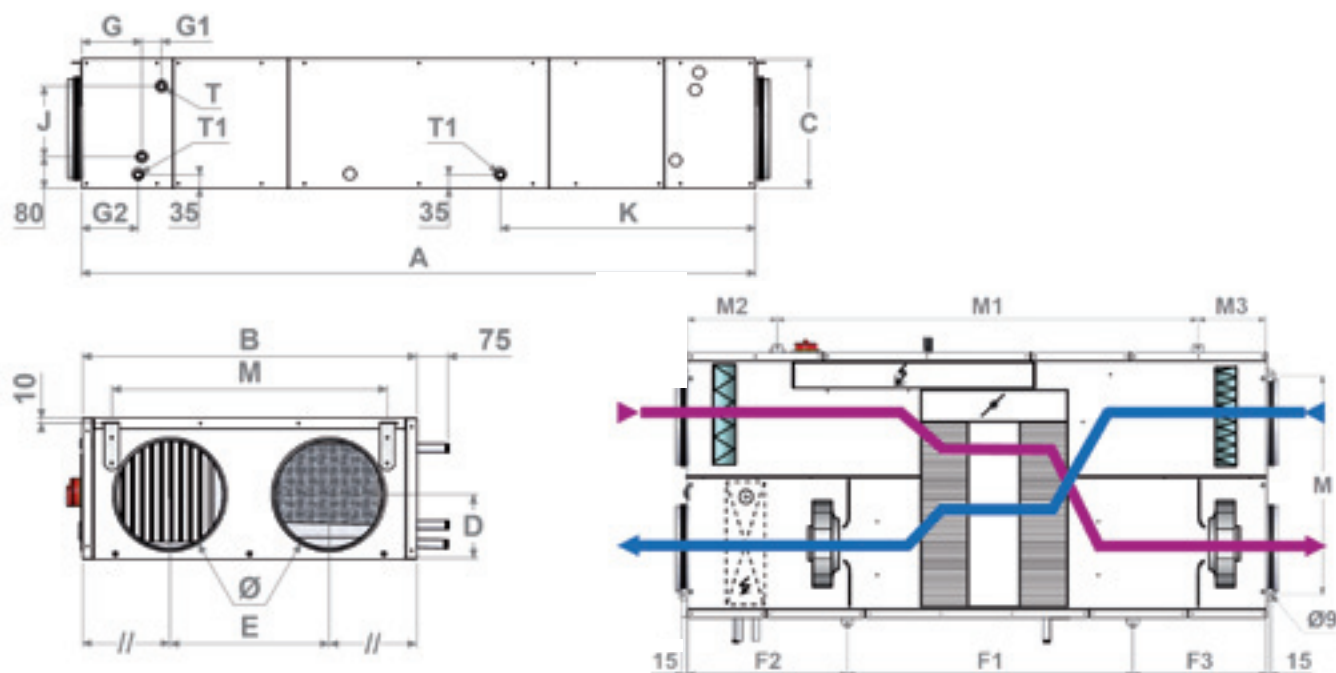

Models	Ø	A	B	C	D	E	F1	F2	F3	G	G1	G2	J	K	M	M1	M2	M3	T	T1
VORT NRG 600 EC	250	1700	780	330	150	370	-	-	-	150	50	145	180	645	640	-	-	-	1/2"	1/2"
VORT NRG 800 EC	315	2020	965	415	210	460	-	-	-	150	50	145	280	780	750	-	-	-	1/2"	1/2"
VORT NRG 1500 EC	355	2195	1220	415	215	600	885	695	615	430	50	145	280	845	950	1075	560	560	1/2"	1/2"
VORT NRG 2000 EC	400	2275	1220	495	245	600	940	715	620	430	50	425	330	885	950	1115	580	580	1/2"	1/2"
VORT NRG 2500 EC	400	2395	1740	495	235	910	840	785	770	430	50	425	330	985	1350	1235	580	580	1/2"	1/2"
VORT NRG 600 EC EH	250	1700	780	330	150	370	-	-	-	150	50	145	180	645	640	-	-	-	1/2"	1/2"
VORT NRG 800 EC EH	315	2020	965	415	210	460	-	-	-	150	50	145	280	780	750	-	-	-	1/2"	1/2"
VORT NRG 1500 EC EH	355	2195	1220	415	215	600	885	695	615	430	50	145	280	845	950	1075	560	560	1/2"	1/2"
VORT NRG 2000 EC EH	400	2275	1220	495	245	600	940	715	620	430	50	425	330	885	950	1115	580	580	1/2"	1/2"
VORT NRG 2500 EC EH	400	2395	1740	495	235	910	840	785	770	430	50	425	330	985	1350	1235	580	580	1/2"	1/2"

Dimensions (mm)

DIMENSIONS MODELS 3000-4500-6000-8000

HORIZONTAL MOUNTING
MODELS 3000 - 4500

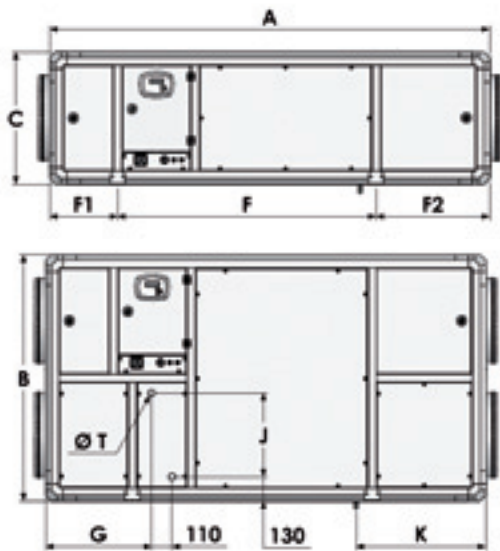

VERTICAL MOUNTING
MODELS 3000 - 4500 - 6000

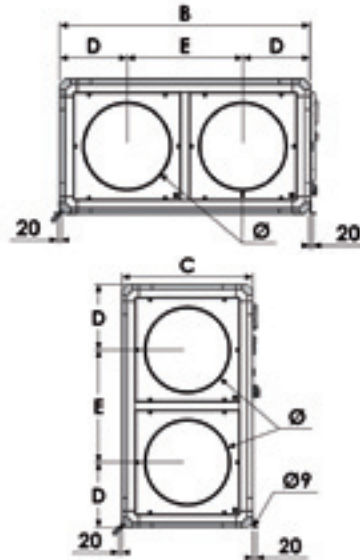

Models	Ø	A	B	C	D	E	F	F1	F2	J	K	Ø T
VORT NRG 3000 EC	450	2345	1315	705	355	605	1376	362	607	445	690	3/4"
VORT NRG 4500 EC	500	2625	1515	805	405	705	1520	450	655	545	740	3/4"
VORT NRG 6000 EC	630	2970	1715	1030	455	805	1677	535	758	645	840	1"
VORT NRG 3000 EC EH	450	2345	1315	705	355	605	1376	362	607	445	690	3/4"
VORT NRG 4500 EC EH	500	2625	1515	805	405	705	1520	450	655	545	740	3/4"
VORT NRG 6000 EC EH	630	2970	1715	1030	455	805	1677	535	758	645	840	1"

Dimensions (mm)

VERTICAL MOUNTING MODEL 8000

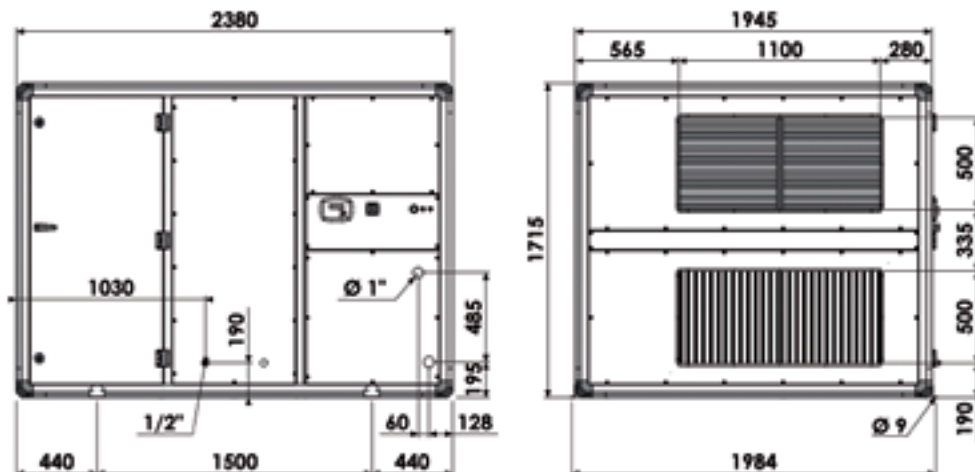



VORT NRG EC RANGE

Heat recovery units equipped with static heat exchangers characterized by high levels of heat exchange efficiency, top performances consumptions

TECHNICAL DATA

Models	Code	Max air flow (m ³ /h)	Pre heater power (kW)	Fans					Electrical power supply				Kg
				Rated power of motors (W)	Operating temperature (°C)	IP class	Insulation class	Thermal overload protection (*)	Voltage (V)	N° phases	Frequency (Hz)	Protection current (A)	
VORT NRG 600 EC	45380	650	-	2X169	-20/+60	IP54	B	PTI	230	1	50	2,8	120
VORT NRG 800 EC	45381	950	-	2X220	-20/+60	IP44	B	PTI	230	1	50	3,4	180
VORT NRG 1500 EC	45382	1550	-	2X400	-20/+40	IP44	F	PTI	230	1	50	8,6	255
VORT NRG 2000 EC	45383	2100	-	2X400	-20/+40	IP44	F	PTI	230	1	50	8,6	275
VORT NRG 2500 EC	45384	2600	-	2X400	-20/+40	IP44	F	PTI	230	1	50	8,6	380
VORT NRG 600 EC EH	45390	650	1.25	2X169	-20/+60	IP54	B	PTI	230	1	50	8,2	127
VORT NRG 800 EC EH	45391	950	2.50	2X220	-20/+60	IP44	B	PTI	230	1	50	14,3	190
VORT NRG 1500 EC EH	45392	1550	3.5	2X400	-20/+40	IP44	F	PTI	230	1	50	23,8	265
VORT NRG 2000 EC EH	45393	2100	3.75	2X400	-20/+40	IP44	F	PTI	230	1	50	24,9	285
VORT NRG 2500 EC EH	45394	2600	5.25	2X400	-20/+40	IP44	F	PTI	230	1	50	31,4	390
VORT NRG 3000 EC	45385	2550	-	2X700	-20/+40	IP54	B	PTI	230	1	50	6,0	395
VORT NRG 4500 EC	45386	5000	-	2X2500	-20/+40	IP54	B	PTI	400	3+N	50	7,7	550
VORT NRG 6000 EC	45387	6500	-	2X1950	-20/+50	IP54	B	PTI	400	3+N	50	6,3	720
VORT NRG 8000 EC	45388	8500	-	2X2730	-20/+60	IP54	F	PTI	400	3+N	50	8,4	900
VORT NRG 3000 EC EH	45395	2550	6,75	2X700	-20/+40	IP54	B	PTI	400	3+N	50	15,7	400
VORT NRG 4500 EC EH	45396	5000	8,25	2x2500	-20/+40	IP54	B	PTI	400	3+N	50	19,6	554
VORT NRG 6000 EC EH	45397	6500	18	2x1950	-20/+50	IP54	B	PTI	400	3+N	50	32,3	725
VORT NRG 8000 EC EH	45398	8500	24,75	2X2730	-20/+60	IP54	F	PTI	400	3+N	50	44,1	915

(*) Built-in thermal cutout

ENERGY DATA

	Models		VORT NRG 600 EC	VORT NRG 800 EC	VORT NRG 1500 EC
	Code	Unit of measure	45380	45381	45382
Supplier's name or trade mark	-		Vortice	Vortice	Vortice
Declared typology	-		UVNR-B**	UVNR-B**	UVNR-B**
Type of drive	-		VSD***	VSD***	VSD***
Type of heat recovery system HRS	-		other	other	other
Thermal efficiency of heat recovery	%		79.7	79.9	82
Nominal NRUV flow rate	m ³ /s		0.1500	0.2300	0.3000
Effective electric power input	kW		0.180	0.250	0.400
SFPint ****	W/(m ³ /s)		1398	1374	1426
Face velocity at design flow rate	m/s		1.64	1.47	1.46
Nominal external pressure (Δ ps, ext)	Pa		219	157	234
Internal pressure drop of ventilation components (Δ ps, int)	Pa		229	190	194
Internal pressure drop of non-ventilation components (Δ ps, add)	Pa		NA*	NA*	NA*
Static efficiency of fans used in accordance with Regulation (EU) N. 327/2011	%		48.9	41.0	35.1
Declared maximum internal leakage rate of the casing of ventilation units	%		NA*	NA*	NA*
Declared maximum external leakage rate of the casing of ventilation units	%		3.5	3.5	3.4
Energy performance energy or classification of the filters	-		NA*	NA*	NA*
Description of visual filter warning	-		See instruction manual	See instruction manual	See instruction manual
Casing sound power level (LWA)	dB(A)		57	59	65

	Models		VORT NRG 2000 EC	VORT NRG 2500 EC	VORT NRG 3000 EC
	Code	Unit of measure	45383	45384	45385
Supplier's name or trade mark	-		Vortice	Vortice	Vortice
Declared typology	-		UVNR-B**	UVNR-B**	UVNR-B**
Type of drive	-		VSD***	VSD***	VSD***
Type of heat recovery system HRS	-		altro	altro	altro
Thermal efficiency of heat recovery	%		80.5	80.5	84
Nominal NRUV flow rate	m ³ /s		0.3500	0.5000	0.6300
Effective electric power input	kW		0.450	0.630	0.760
SFPint ****	W/(m ³ /s)		1384	1352	1454
Face velocity at design flow rate	m/s		1.38	1.52	1.74
Nominal external pressure (Δ ps, ext)	Pa		234	274	244
Internal pressure drop of ventilation components (Δ ps, int)	Pa		201	258	248
Internal pressure drop of non-ventilation components (Δ ps, add)	Pa		NA*	NA*	NA*
Static efficiency of fans used in accordance with Regulation (EU) N. 327/2011	%		38.7	43.4	52.4
Declared maximum internal leakage rate of the casing of ventilation units	%		NA*	NA*	NA*
Declared maximum external leakage rate of the casing of ventilation units	%		3.2	3.2	2.2
Energy performance energy or classification of the filters	-		NA*	NA*	NA*
Description of visual filter warning	-		See instruction manual	See instruction manual	See instruction manual
Casing sound power level (LWA)	dB(A)		65	66	59

* NA: Not applicable.

** UVNR-B: Non Residential Ventilation units - Bidirectional.

*** VSD: Multiple speed.

**** SFPint: Specific power of the internal components of the ventilation.



VORT NRG EC RANGE

Heat recovery units equipped with static heat exchangers characterized by high levels of heat exchange efficiency, top performances consumptions

ENERGY DATA

	Models		VORT NRG 4500 EC	VORT NRG 6000 EC	VORT NRG 8000 EC
	Code	Unit of measure	45386	45387	45388
Supplier's name or trade mark	-		Vortice	Vortice	Vortice
Declared typology	-		UVNR-B**	UVNR-B**	UVNR-B**
Type of drive	-		VSD***	VSD***	VSD***
Type of heat recovery system HRS	-		other	other	other
Thermal efficiency of heat recovery	%		83.7	83.4	83
Nominal NRUV flow rate	m ³ /s		0.9600	1.3200	1.7800
Effective electric power input	kW		1.850	2.130	2.980
SFPint ****	W/(m ³ /s)		1395	1324	1251
Face velocity at design flow rate	m/s		1.95	1.79	1.20
Nominal external pressure (Δps, ext)	Pa		717	548	615
Internal pressure drop of ventilation components (Δps, int)	Pa		258	214	195
Internal pressure drop of non-ventilation components (Δps, add)	Pa		NA*	NA*	NA*
Static efficiency of fans used in accordance with Regulation (EU) N. 327/2011	%		59.3	61.2	61.8
Declared maximum internal leakage rate of the casing of ventilation units	%		NA*	NA*	NA*
Declared maximum external leakage rate of the casing of ventilation units	%		2.0	1.8	1.7
Energy performance energy or classification of the filters	-		NA*	NA*	NA*
Description of visual filter warning	-		See instruction manual	See instruction manual	See instruction manual
Casing sound power level (LWA)	dB(A)		61	60	59

	Models		VORT NRG 600 EC EH	VORT NRG 800 EC EH	VORT NRG 1500 EC EH
	Code	Unit of measure	45390	45391	45392
Supplier's name or trade mark	-		Vortice	Vortice	Vortice
Declared typology	-		UVNR-B**	UVNR-B**	UVNR-B**
Type of drive	-		VSD***	VSD***	VSD***
Type of heat recovery system HRS	-		other	other	other
Thermal efficiency of heat recovery	%		79.7	79.9	82
Nominal NRUV flow rate	m ³ /s		0.1500	0.2300	0.3000
Effective electric power input	kW		0.180	0.250	0.400
SFPint ****	W/(m ³ /s)		1398	1374	1426
Face velocity at design flow rate	m/s		1.64	1.47	1.46
Nominal external pressure (Δps, ext)	Pa		219	157	234
Internal pressure drop of ventilation components (Δps, int)	Pa		229	190	194
Internal pressure drop of non-ventilation components (Δps, add)	Pa		NA*	NA*	NA*
Static efficiency of fans used in accordance with Regulation (EU) N. 327/2011	%		48.9	41.0	35.1
Declared maximum internal leakage rate of the casing of ventilation units	%		NA*	NA*	NA*
Declared maximum external leakage rate of the casing of ventilation units	%		3.5	3.5	3.4
Energy performance energy or classification of the filters	-		NA*	NA*	NA*
Description of visual filter warning	-		See instruction manual	See instruction manual	See instruction manual
Casing sound power level (LWA)	dB(A)		57	59	65

* NA: Not applicable.

** UVNR-B: Non Residential Ventilation units - Bidirectional.

*** VSD: Multiple speed.

**** SFPint: Specific power of the internal components of the ventilation.

ENERGY DATA

	Models	Unit of measure	VORT NRG 2000	VORT NRG 2500	VORT NRG 3000
	Code		EC EH 45393	EC EH 45394	EC EH 45395
Supplier's name or trade mark		-	Vortice	Vortice	Vortice
Declared typology		-	UVNR-B**	UVNR-B**	UVNR-B**
Type of drive		-	VSD***	VSD***	VSD***
Type of heat recovery system HRS		-	other	other	other
Thermal efficiency of heat recovery		%	80.5	80.5	84
Nominal NRVC flow rate		m ³ /s	0.3500	0.5000	0.6300
Effective electric power input		kW	0.450	0.630	0.760
SFPint ****		W/(m ³ /s)	1384	1352	1454
Face velocity at design flow rate		m/s	1.38	1.52	1.74
Nominal external pressure (Δp_s , ext)		Pa	234	274	244
Internal pressure drop of ventilation components (Δp_s , int)		Pa	201	258	248
Internal pressure drop of non-ventilation components (Δp_s , add)		Pa	NA*	NA*	NA*
Static efficiency of fans used in accordance with Regulation (EU) N. 327/2011		%	38.7	43.4	52.4
Declared maximum internal leakage rate of the casing of ventilation units		%	NA*	NA*	NA*
Declared maximum external leakage rate of the casing of ventilation units		%	3.2	3.2	2.2
Energy performance energy or classification of the filters		-	NA*	NA*	NA*
Description of visual filter warning		-	See instruction manual	See instruction manual	See instruction manual
Casing sound power level (LWA)		dB(A)	65	66	59

	Models	Unit of measure	VORT NRG 4500	VORT NRG 6000	VORT NRG 8000
	Code		EC EH 45396	EC EH 45397	EC EH 45398
Supplier's name or trade mark		-	Vortice	Vortice	Vortice
Declared typology		-	UVNR-B**	UVNR-B**	UVNR-B**
Type of drive		-	VSD***	VSD***	VSD***
Type of heat recovery system HRS		-	other	other	other
Thermal efficiency of heat recovery		%	83.7	83.4	83
Nominal NRVC flow rate		m ³ /s	0.9600	1.3200	1.7800
Effective electric power input		kW	1.850	2.130	2.980
SFPint ****		W/(m ³ /s)	1395	1324	1251
Face velocity at design flow rate		m/s	1.95	1.79	1.20
Nominal external pressure (Δp_s , ext)		Pa	717	548	615
Internal pressure drop of ventilation components (Δp_s , int)		Pa	258	214	195
Internal pressure drop of non-ventilation components (Δp_s , add)		Pa	NA*	NA*	NA*
Static efficiency of fans used in accordance with Regulation (EU) N. 327/2011		%	59.3	61.2	61.8
Declared maximum internal leakage rate of the casing of ventilation units		%	NA*	NA*	NA*
Declared maximum external leakage rate of the casing of ventilation units		%	2.0	1.8	1.7
Energy performance energy or classification of the filters		-	NA*	NA*	NA*
Description of visual filter warning		-	See instruction manual	See instruction manual	See instruction manual
Casing sound power level (LWA)		dB(A)	61	60	59

* NA: Not applicable.

** UVNR-B: Ventilation Non Residential Ventilation units - Bidirectional.

*** VSD: Multiple speed.

**** SFPint: Specific power of the internal components of the ventilation.



VORT NRG EC RANGE

Heat recovery units equipped with static heat exchangers characterized by high levels of heat exchange efficiency, top performances consumptions

PERFORMANCE AND ENERGY USAGE

VORT NRG 600 EC - EC EH

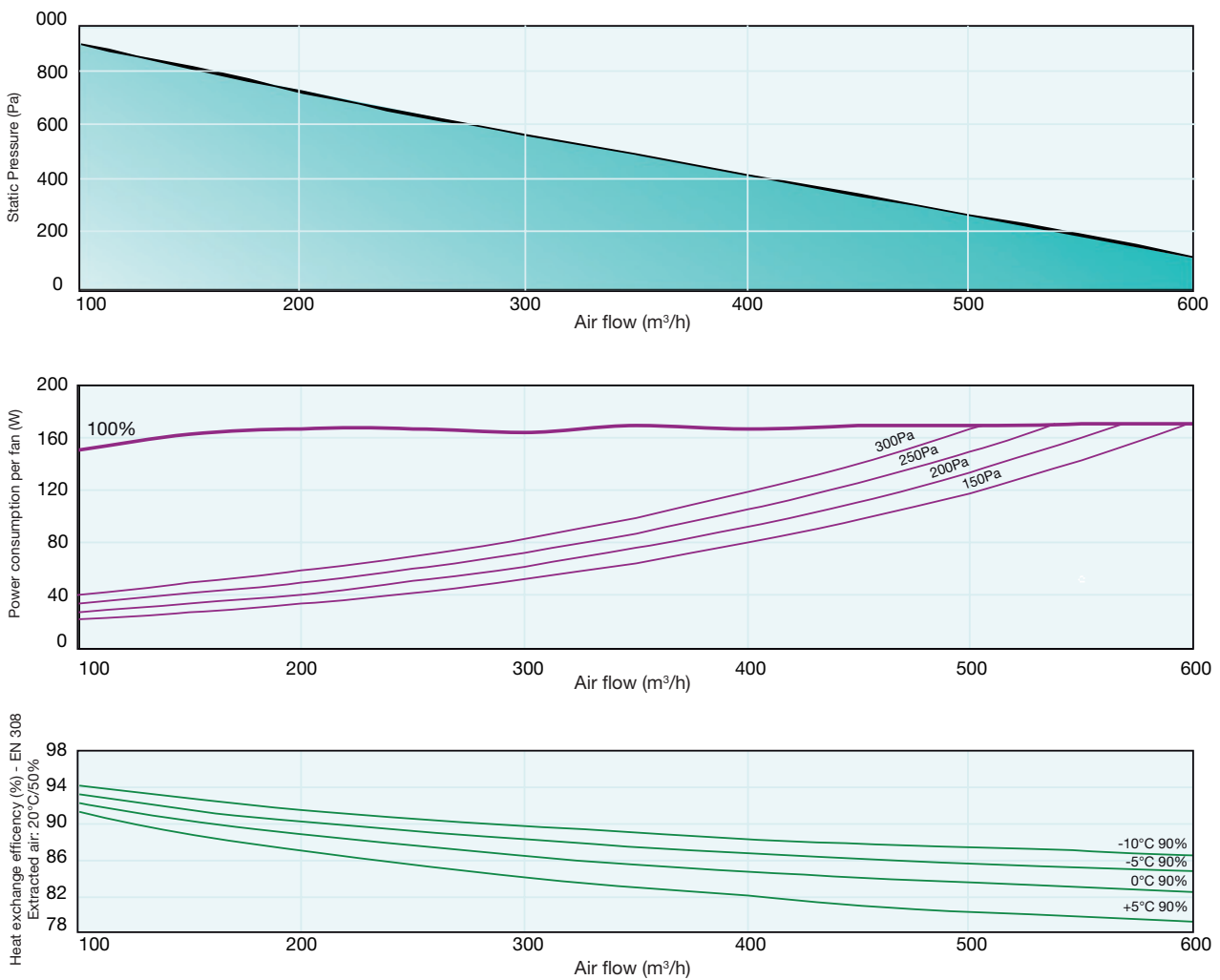

PERFORMANCE AND ENERGY USAGE

VORT NRG 800 EC - EC EH

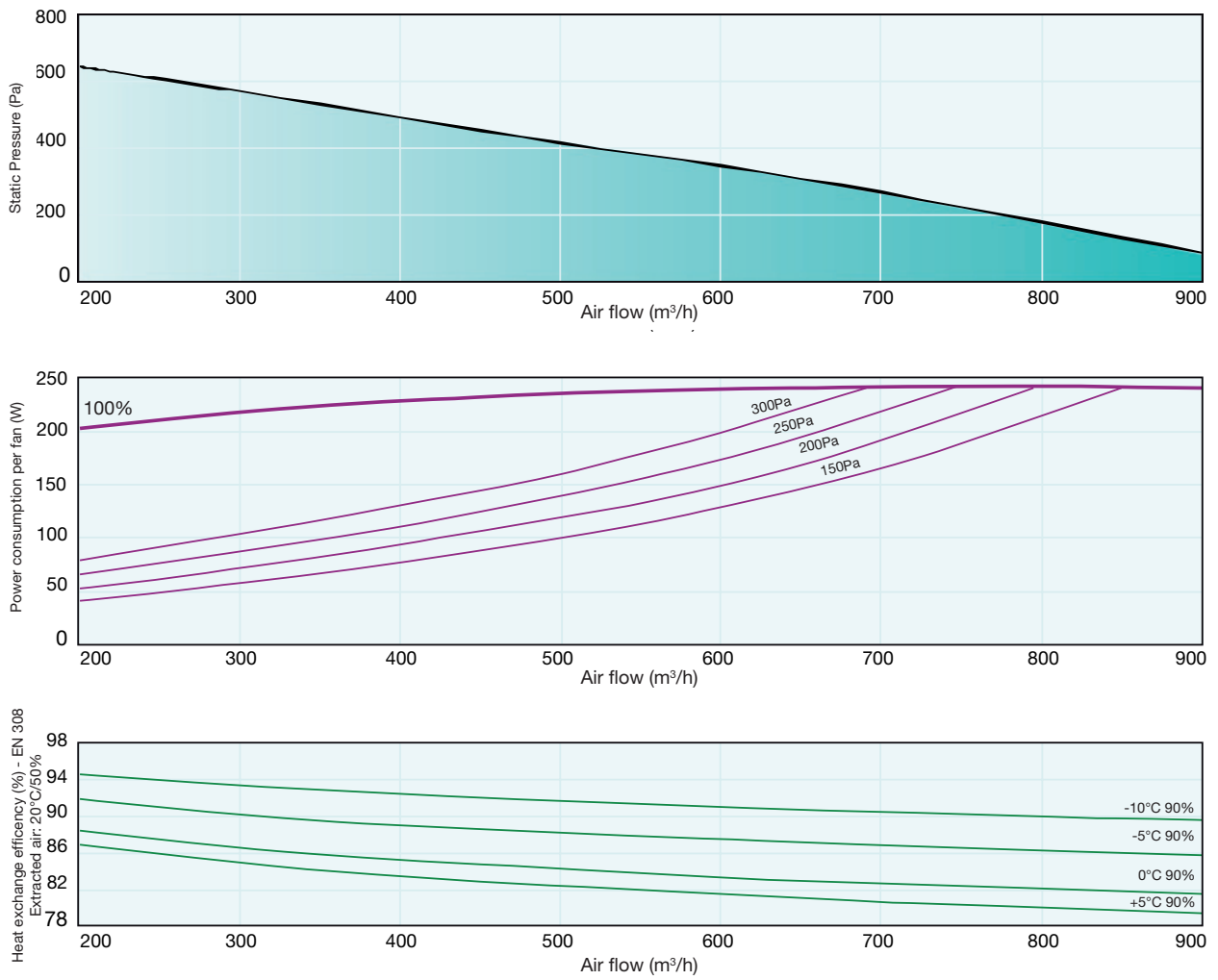



VORT NRG EC RANGE

Heat recovery units equipped with static heat exchangers characterized by high levels of heat exchange efficiency, top performances consumptions

PERFORMANCE AND ENERGY USAGE

VORT NRG 1500 EC - EC EH

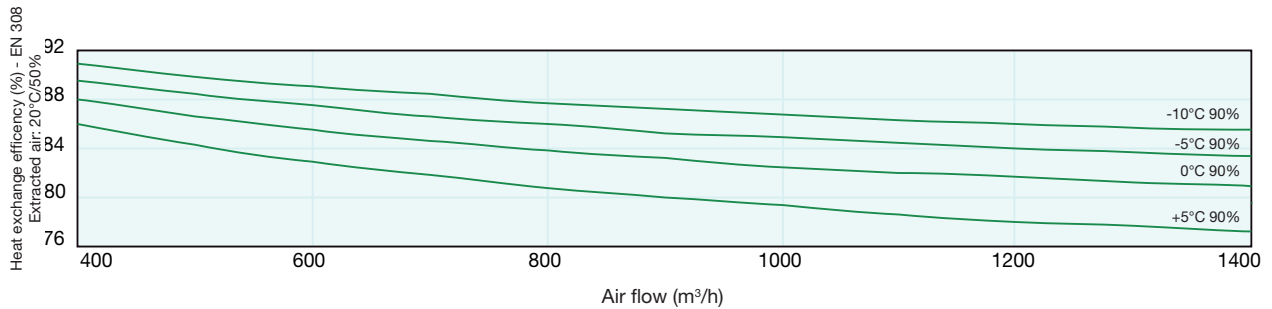
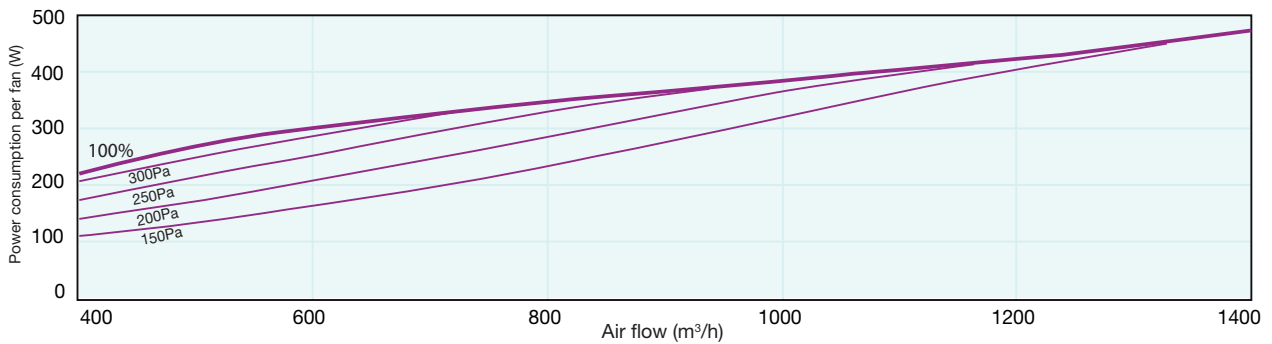
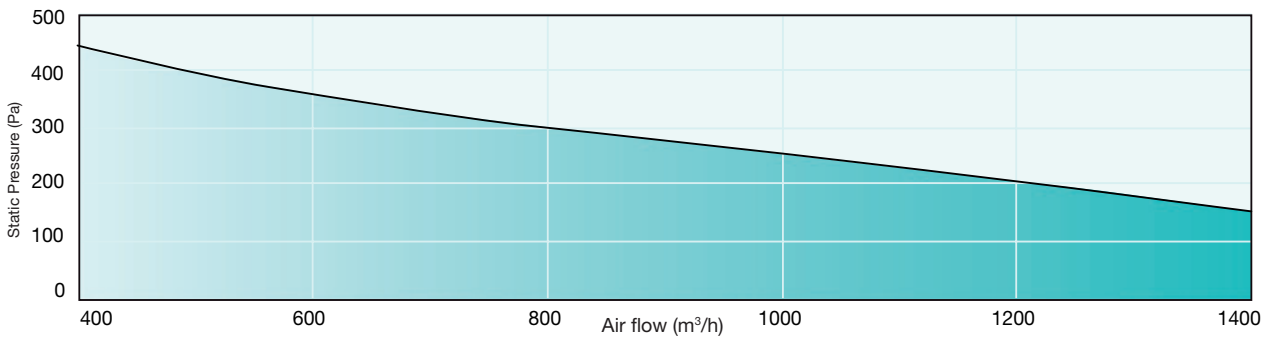

PERFORMANCE AND ENERGY USAGE

VORT NRG 2000 EC - EC EH

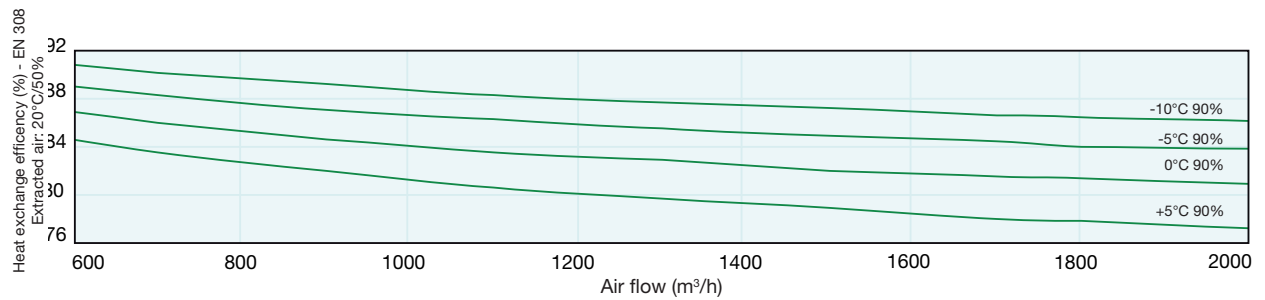
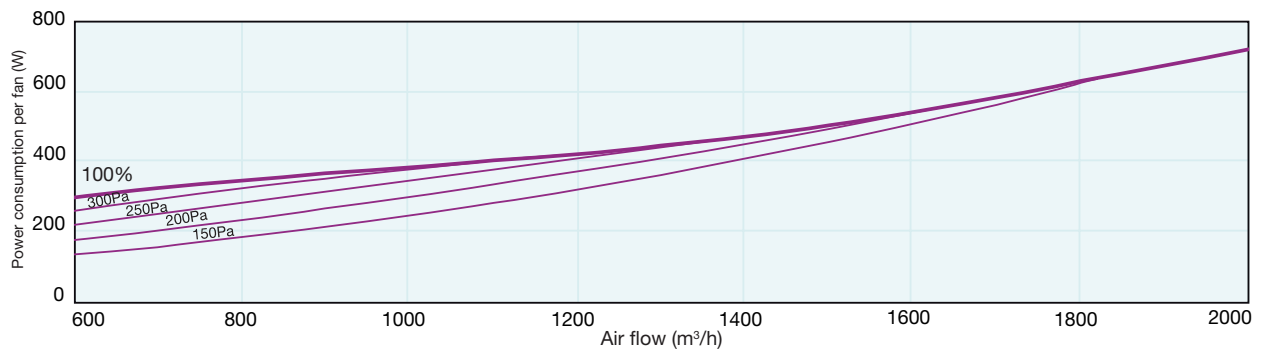
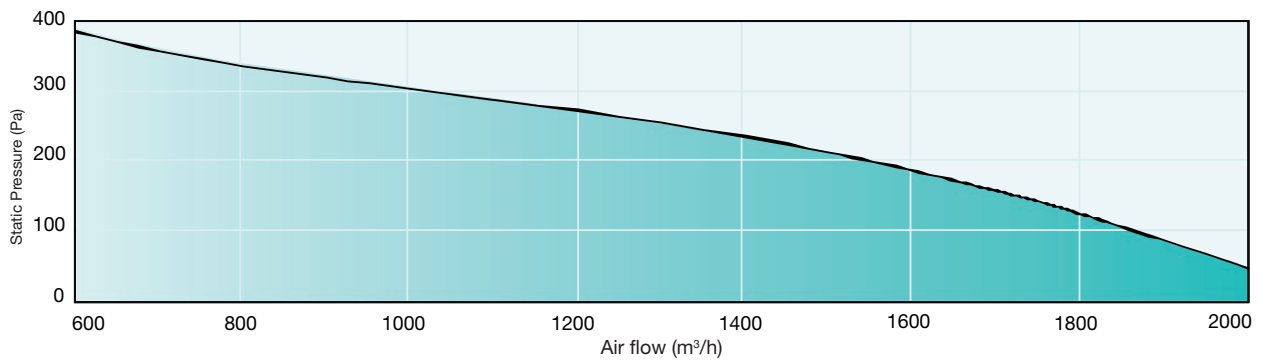



VORT NRG EC RANGE

Heat recovery units equipped with static heat exchangers characterized by high levels of heat exchange efficiency, top performances consumptions

PERFORMANCE AND ENERGY USAGE

VORT NRG 2500 EC - EC EH

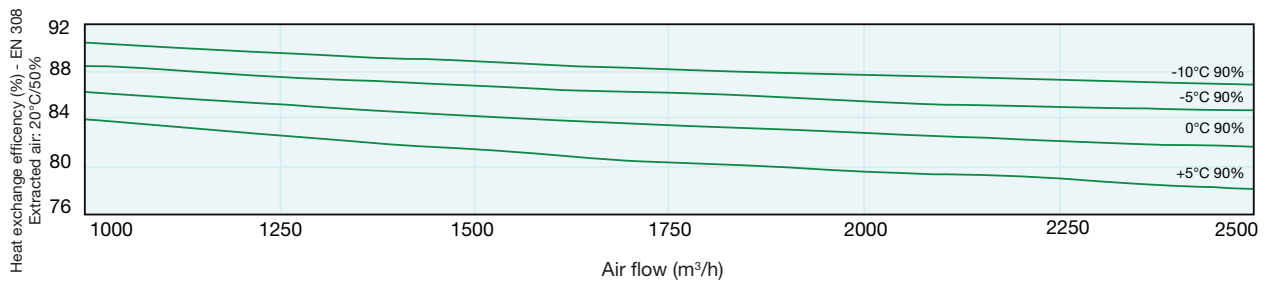
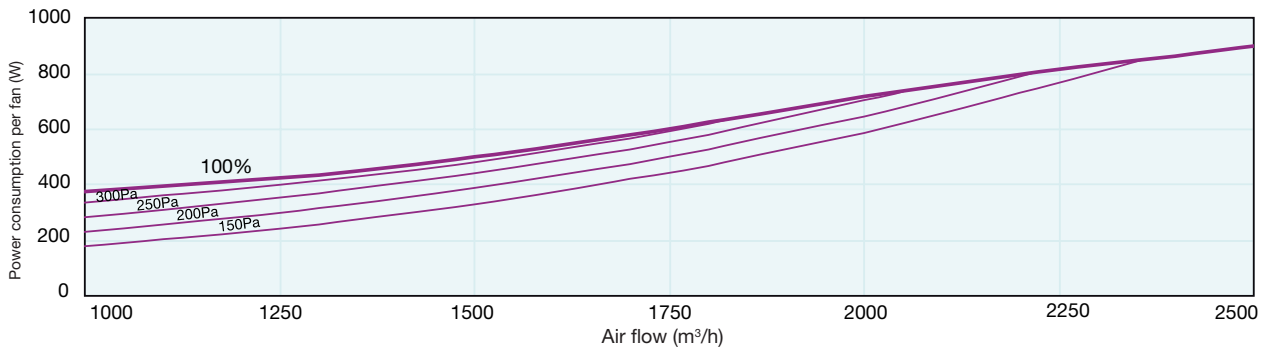
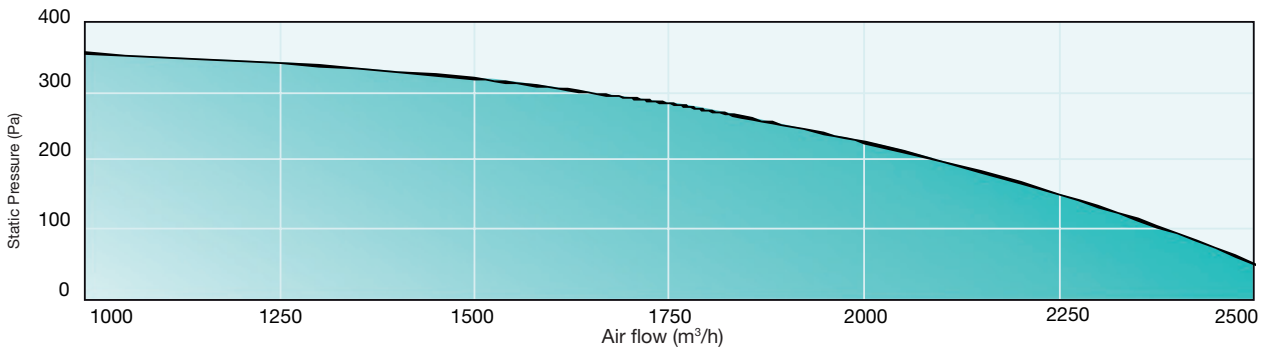

PERFORMANCE AND ENERGY USAGE

VORT NRG 3000 EC - EC EH

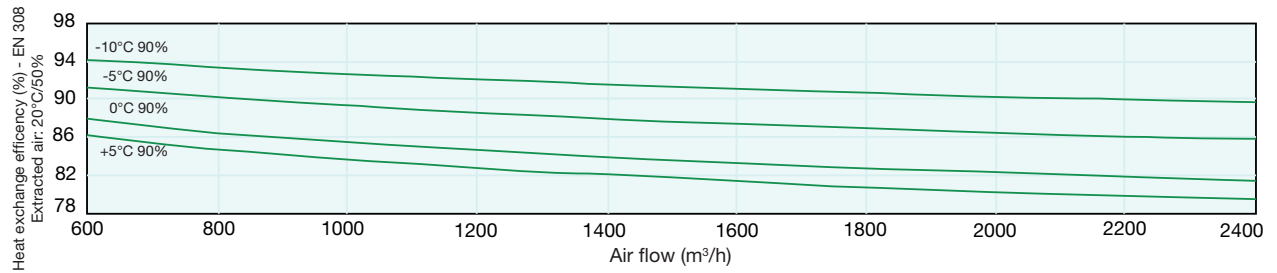
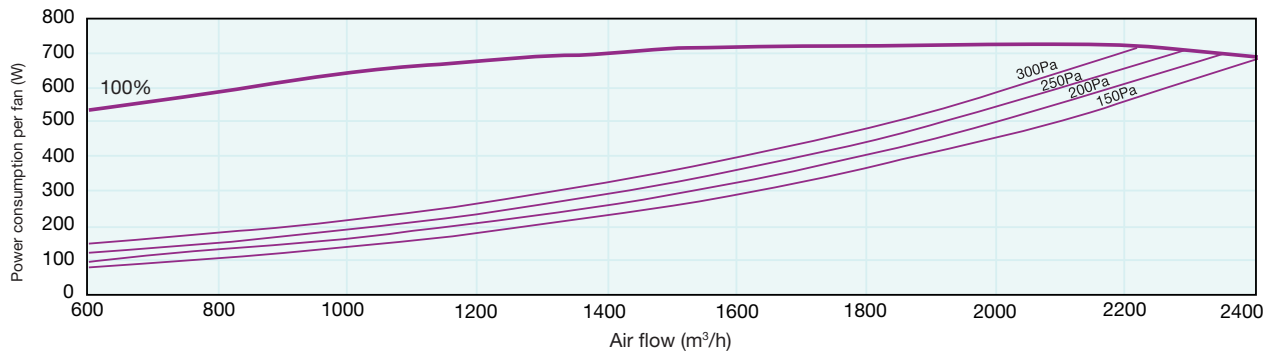
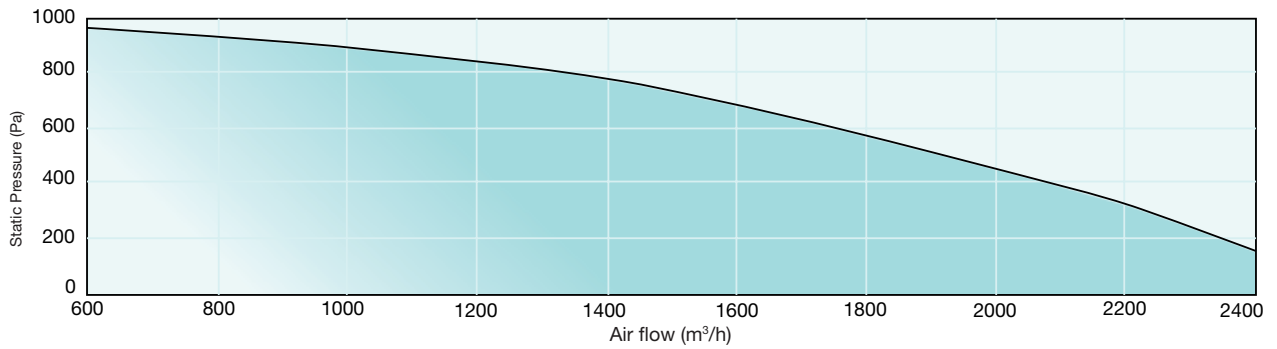



VORT NRG EC RANGE

Heat recovery units equipped with static heat exchangers characterized by high levels of heat exchange efficiency, top performances consumptions

PERFORMANCE AND ENERGY USAGE

VORT NRG 4500 EC - EC EH

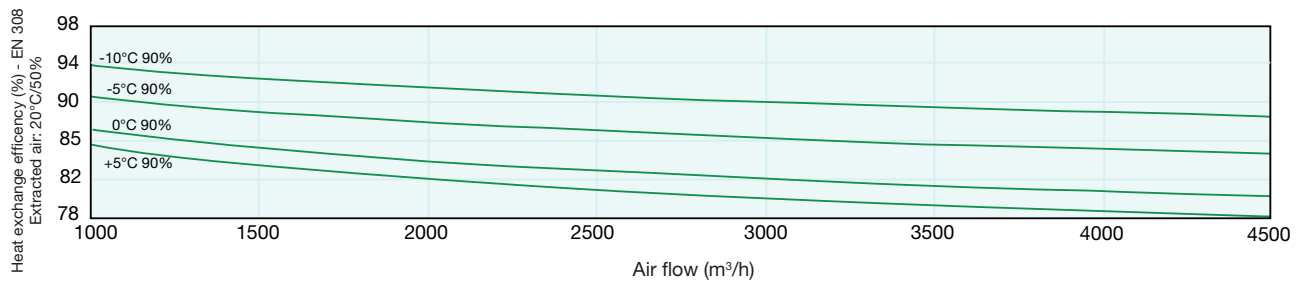
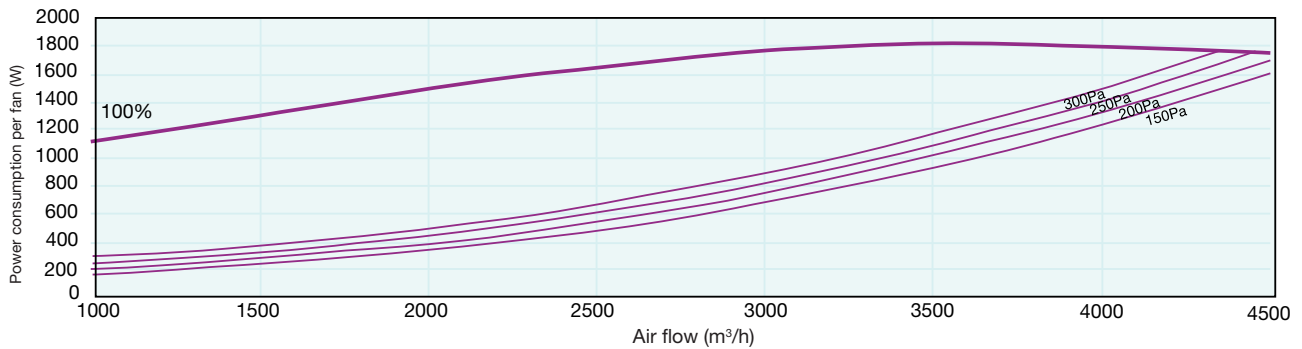
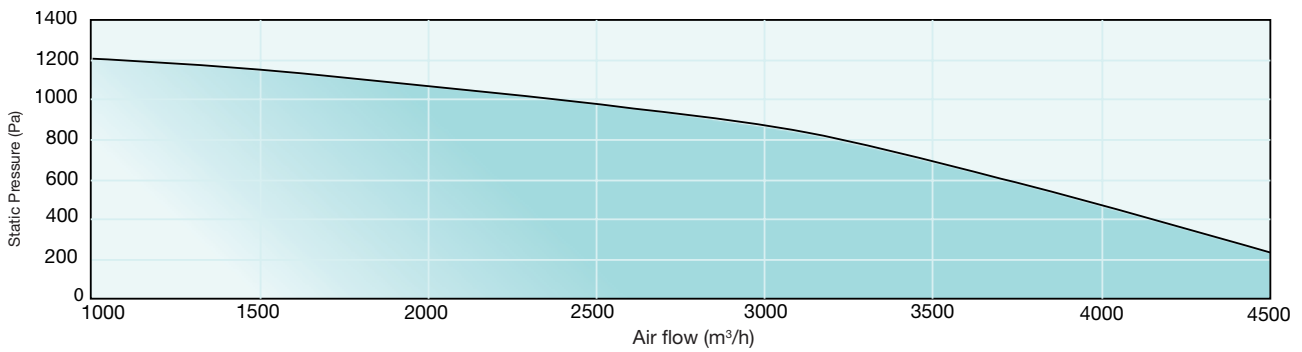

PERFORMANCE AND ENERGY USAGE

VORT NRG 6000 EC - EC EH

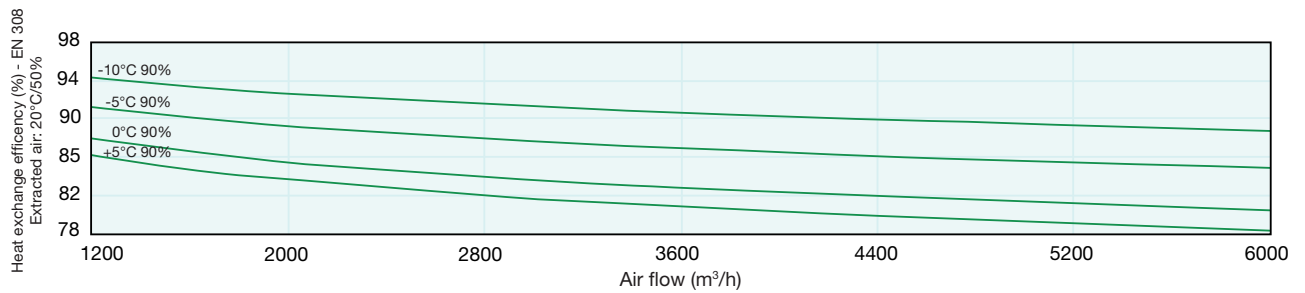
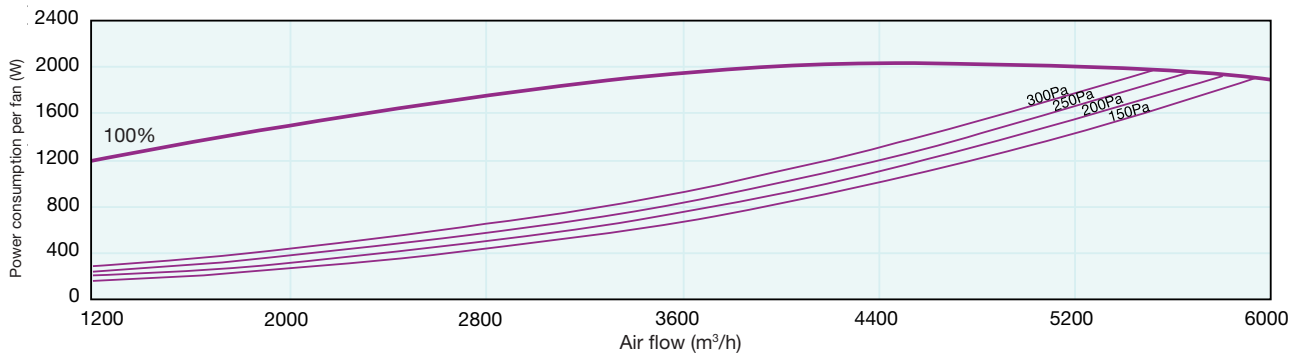
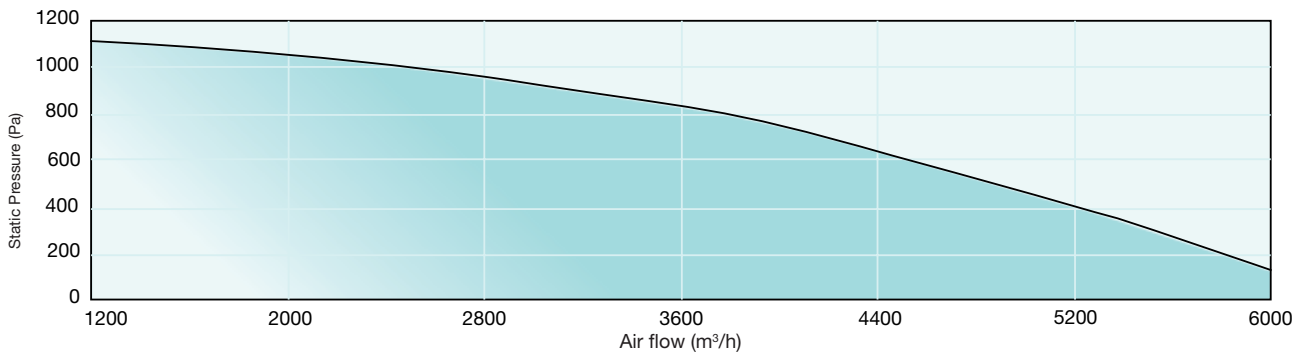



VORT NRG EC RANGE

Heat recovery units equipped with static heat exchangers characterized by high levels of heat exchange efficiency, top performances consumptions

PERFORMANCE AND ENERGY USAGE

VORT NRG 8000 EC - EC EH

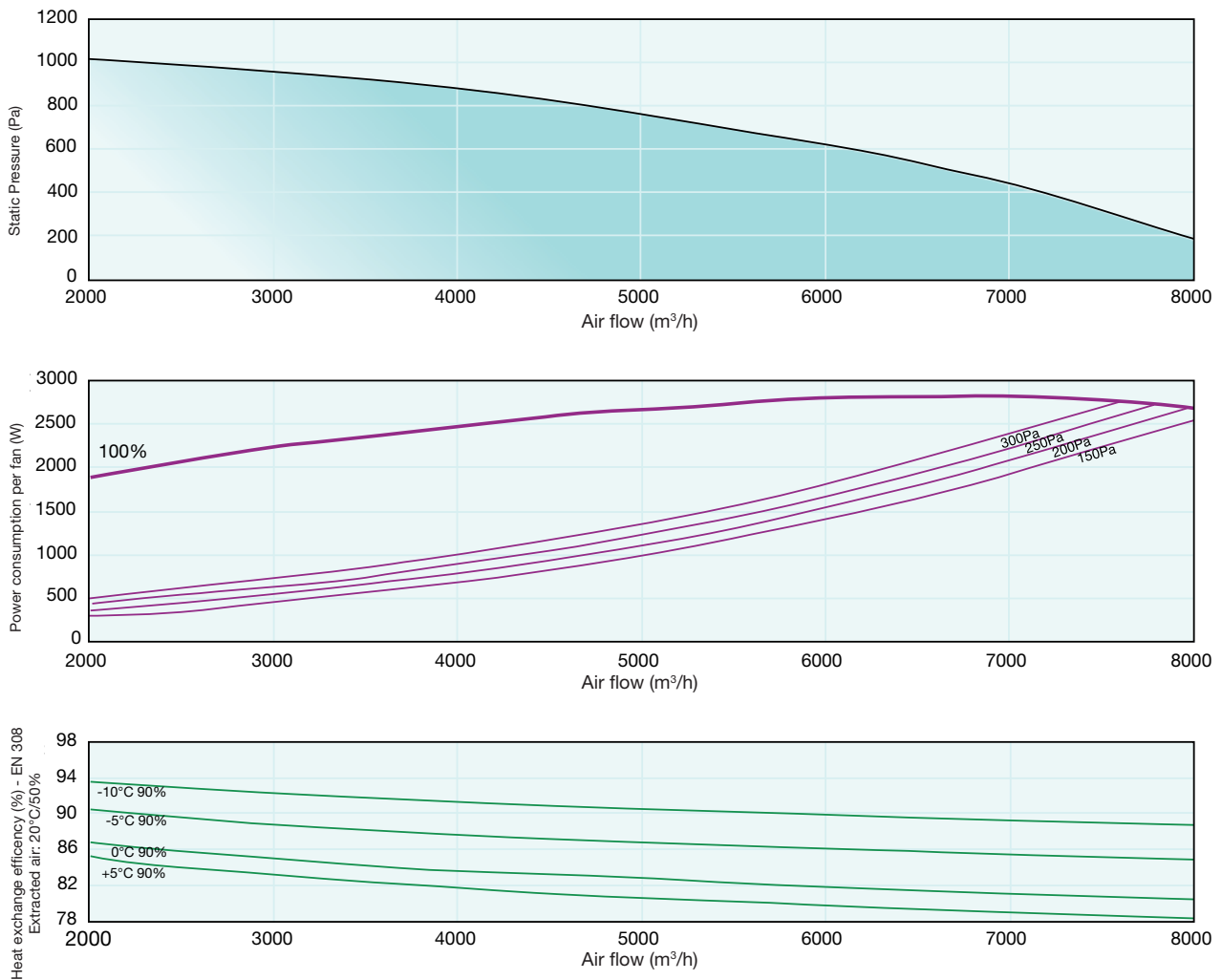

VORT NRG EC RANGE

Heat recovery units equipped with static heat exchangers characterized by high levels of heat exchange efficiency, top performances consumptions

NOISE EMISSIONS

The “**Lp4m**” curves indicate the sound pressure level measured at 4m in free field conditions, with hemispherical distribution on a reflecting plane, leaving the ports of the appliance unconnected on the “outdoors” side (“fresh air intake” and “stale air extract”) and connecting the ports on the “indoors” side (“fresh air supply” and “stale air extract”).

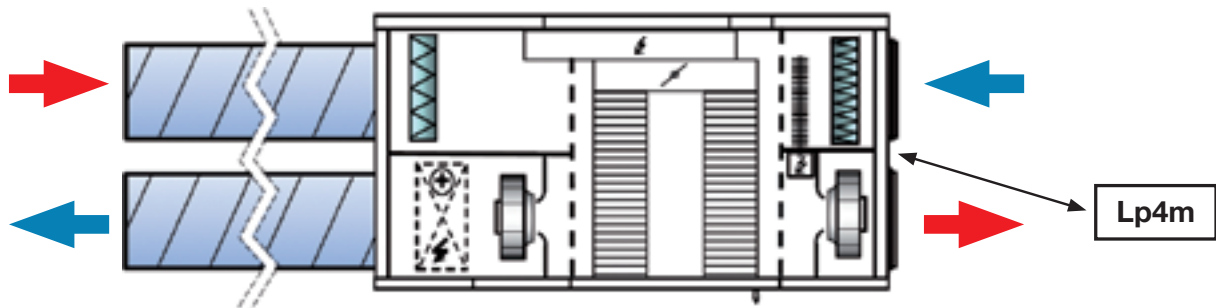

To obtain the overall sound pressure level L_p in dB(A) at a given distance, add the following values to the data indicated by the $L_{p_{4m}}$ curves:

Distance (m)	1,5	3	4	5	7	10
Weighting on the basis of distance dB(A)	9	3	0	-2	-5	-8

To obtain sound pressure level NSC4 dB(A) (sound pressure measured at 4 m in free field conditions with hemispherical distribution, placing the appliance on reflecting plane, with inlet and outlet ports connected to ducts having the same sound insulation properties), subtract **18 dB(A)** from the “**Lp4m**” value indicated by the curves..

The “**Lw supply dB(A)**” curves correspond to overall sound power radiated in the vicinity of the two ports “**fresh air supply**” and “**stale air expel**”.

To obtain the L_w sound power spectrum at the sides of the “**fresh air intake**” or “**stale air extract**” ports, add the values tabulated below to the “**Lw supply duct**” sound power data indicated by the curves.

Weighting of downstream sound spectrum of “ Lw supply dB(A) ” indicated by the curves								
Frequency	63 Hz	125 Hz	250 Hz	500 Hz	1000 Hz	2000 Hz	4000 Hz	8000 Hz
VORT NRG 600 EC/EC EH	-37	-26	-15	-7	-5	-6	-9	-11
VORT NRG 800 EC/EC EH	-29	-17	-11	-7	-5	-5	-11	-18
VORT NRG 1500 EC/EC EH	-31	-20	-5	-8	-6	-8	-10	-16
VORT NRG 2000 EC/EC EH	-32	-20	-6	-8	-6	-8	-10	-13
VORT NRG 2500 EC/EC EH	-37	-23	-7	-8	-6	-7	-9	-13
VORT NRG 3000 EC/EC EH	-28	-26	-15	-9	-6	-4	-11	-14
VORT NRG 4500 EC/EC EH	-32	-20	-12	-7	-4	-7	-11	-19
VORT NRG 6000 EC/EC EH	-35	-20	-13	-7	-4	-7	-11	-18
VORT NRG 8000 EC/EC EH	-39	-29	-12	-7	-4	-7	-11	-16

NOISE EMISSIONS

The “**Lw extract dB(A)**” curves correspond to overall sound power radiated in the vicinity of the two ports “**stale air extract**” and “**fresh air intake**”.

To obtain the **Lw** sound power spectrum at the sides of the “**stale air extract**” or “**fresh air intake**” ports, add the values tabulated below to the “**Lw extract**” sound power data indicated by the curves.

Weighting of upstream sound spectrum of “Lw extract dB(A)” indicated by the curves								
Frequency	63 Hz	125 Hz	250 Hz	500 Hz	1000 Hz	2000 Hz	4000 Hz	8000 Hz
VORT NRG 600 EC/EC EH	-32	-24	-14	-7	-5	-5	-11	-15
VORT NRG 800 EC/EC EH	-21	-12	-7	-5	-6	-10	-16	-22
VORT NRG 1500 EC/EC EH	-28	-19	-4	-8	-6	-8	-16	-23
VORT NRG 2000 EC/EC EH	-30	-19	-4	-8	-6	-8	-15	-20
VORT NRG 2500 EC/EC EH	-33	-21	-5	-8	-6	-7	-14	-20
VORT NRG 3000 EC/EC EH	-19	-20	-9	-6	-6	-8	-12	-15
VORT NRG 4500 EC/EC EH	-21	-13	-7	-5	-8	-9	-15	-21
VORT NRG 6000 EC/EC EH	-24	-12	-8	-5	-8	-8	-13	-21
VORT NRG 8000 EC/EC EH	-32	-23	-6	-6	-8	-8	-13	-17

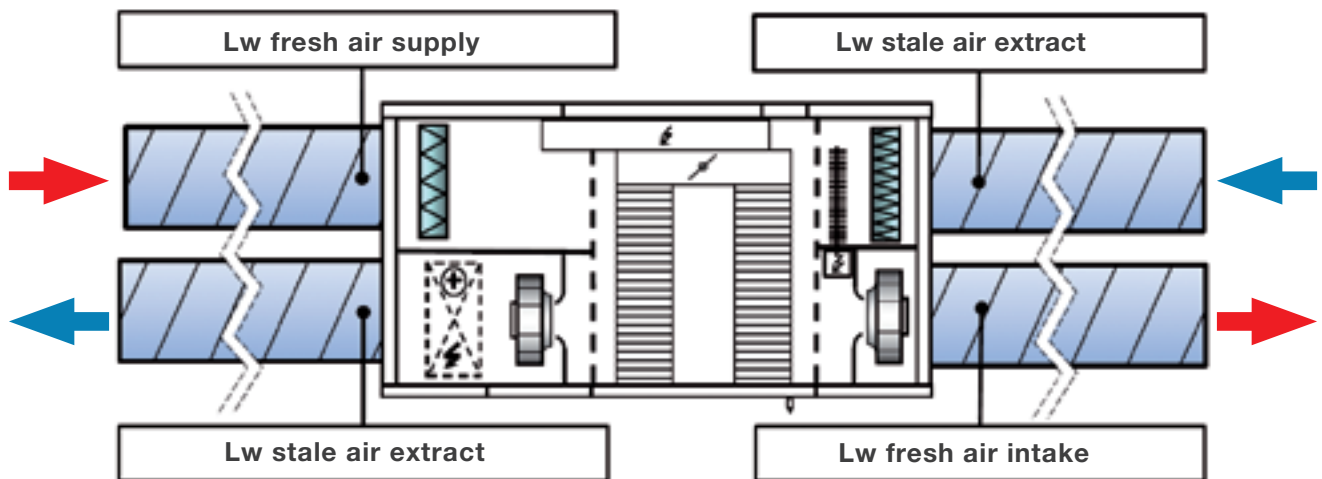

Tolerances:

Overall values: +/- 3 dB(A)

Sound spectrum: +/- 5 dB(A)



VORT NRG EC RANGE

Heat recovery units equipped with static heat exchangers characterized by high levels of heat exchange efficiency, top performances consumptions

NOISE EMISSIONS

VORT NRG 600 EC - EC EH

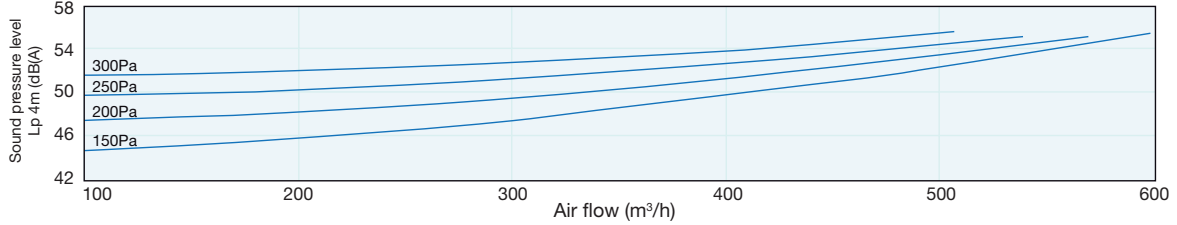
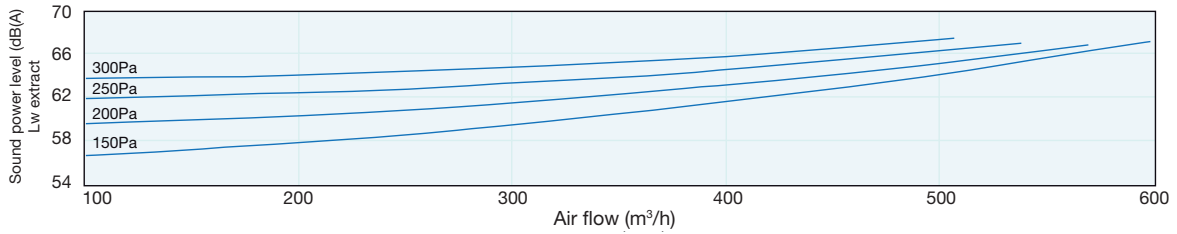
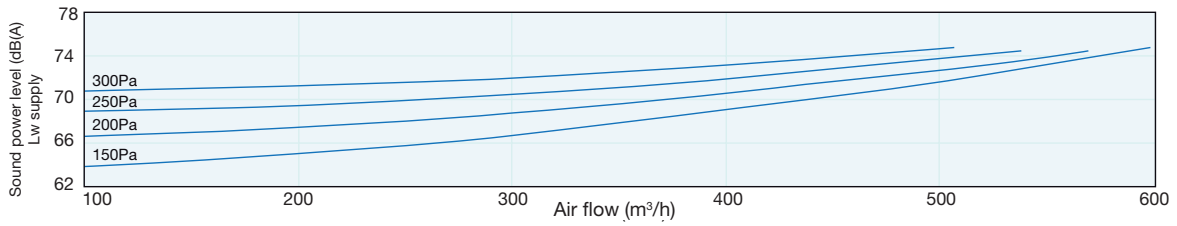

VORT NRG 800 EC - EC EH

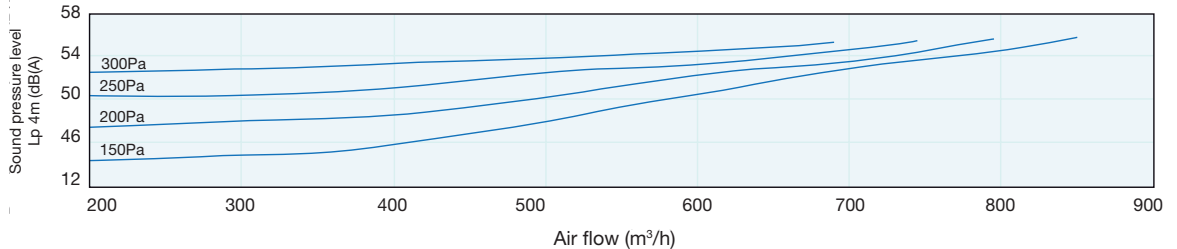
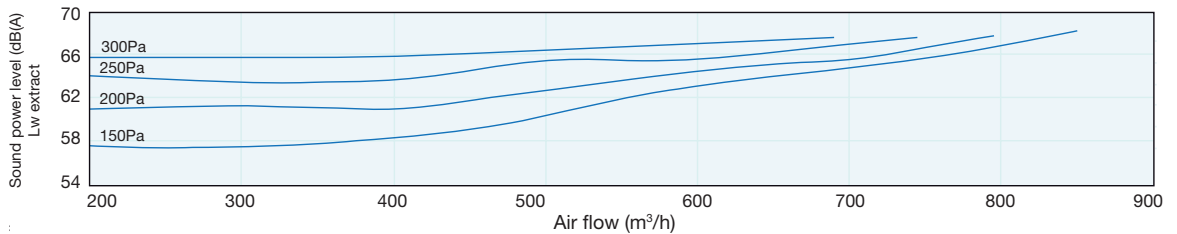
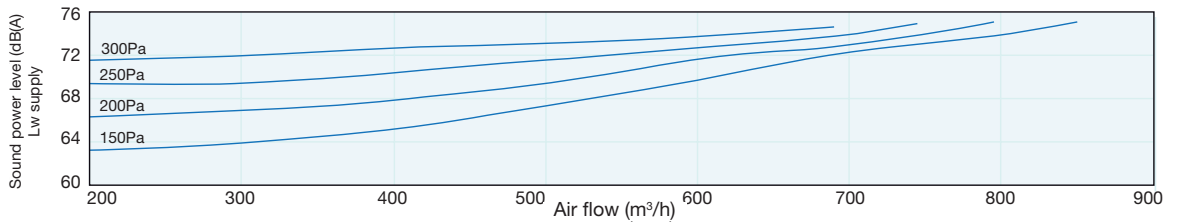

NOISE EMISSIONS

VORT NRG 1500 EC - EC EH

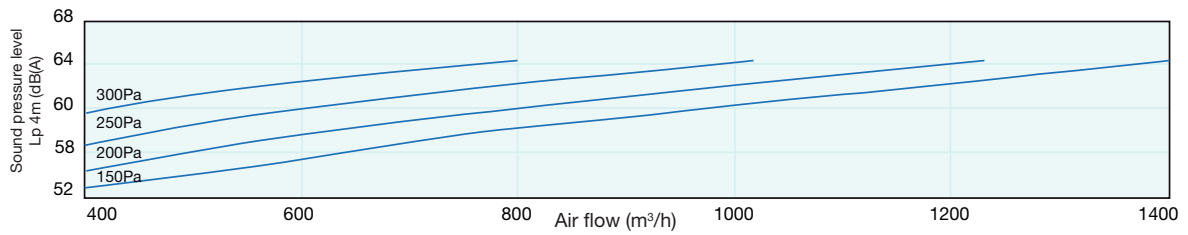
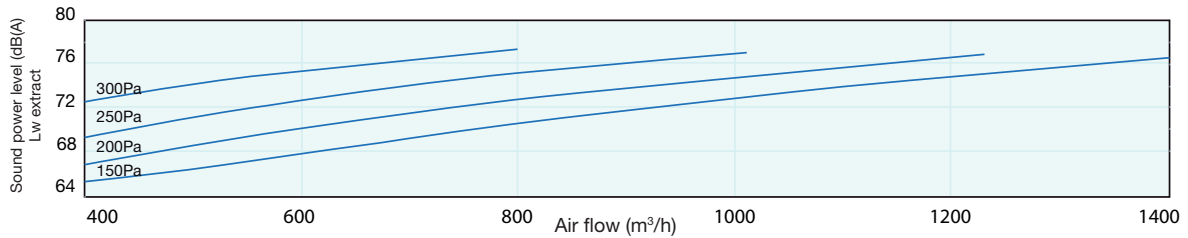
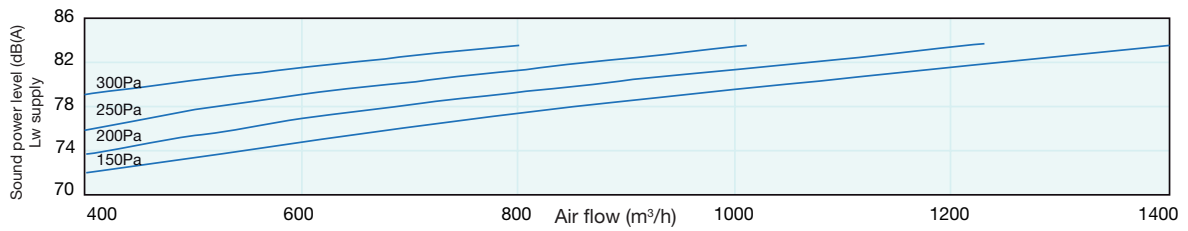

VORT NRG 2000 EC - EC EH

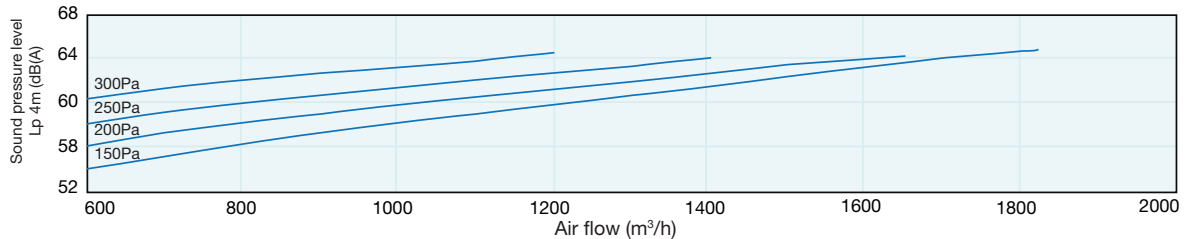
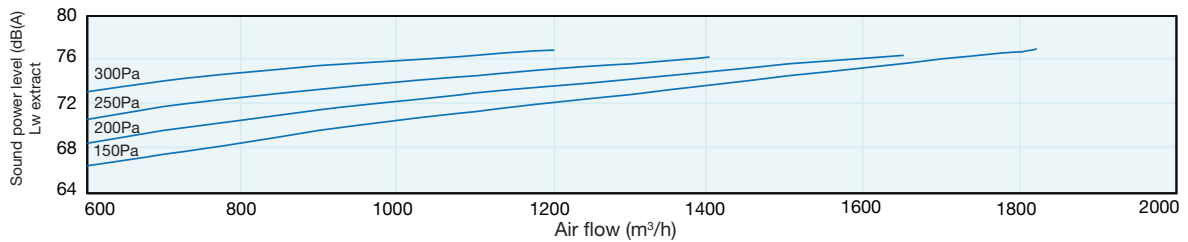
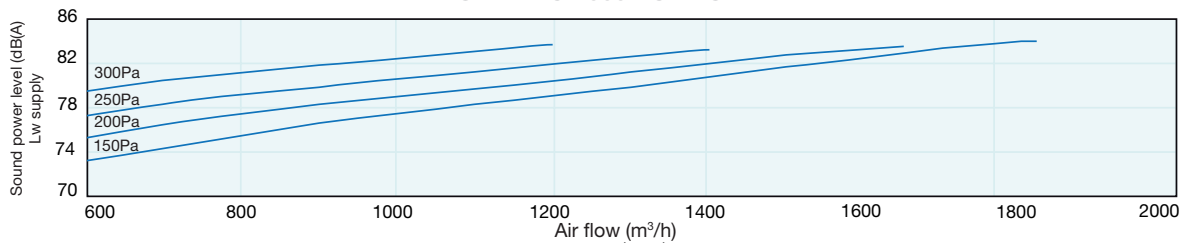



VORT NRG EC RANGE

Heat recovery units equipped with static heat exchangers characterized by high levels of heat exchange efficiency, top performance and low energy use

NOISE EMISSIONS

VORT NRG 2500 EC - EC EH

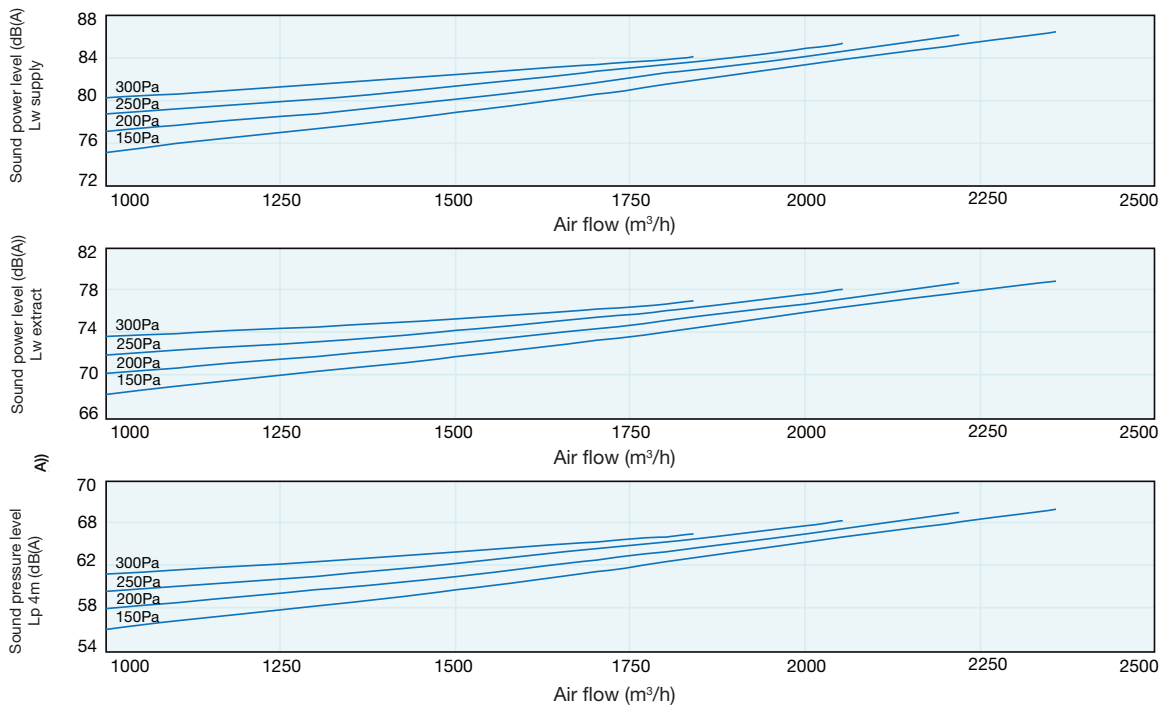

VORT NRG 3000 EC - EC EH

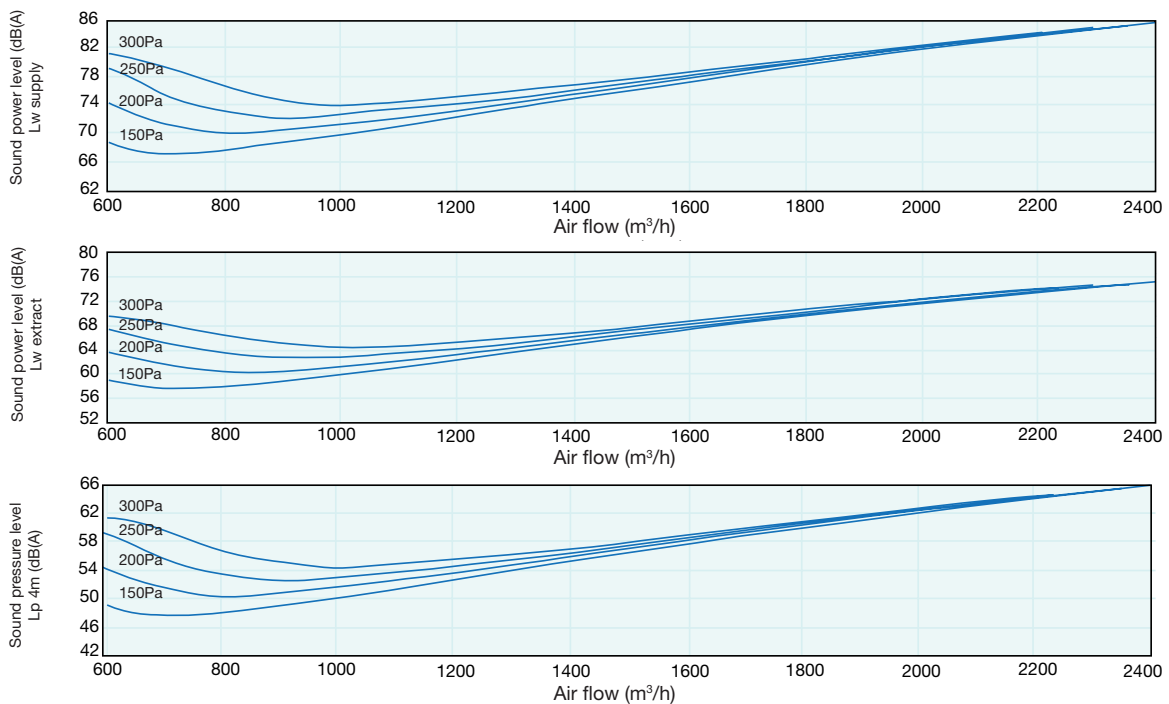

NOISE EMISSIONS

VORT NRG 4500 EC - EC EH

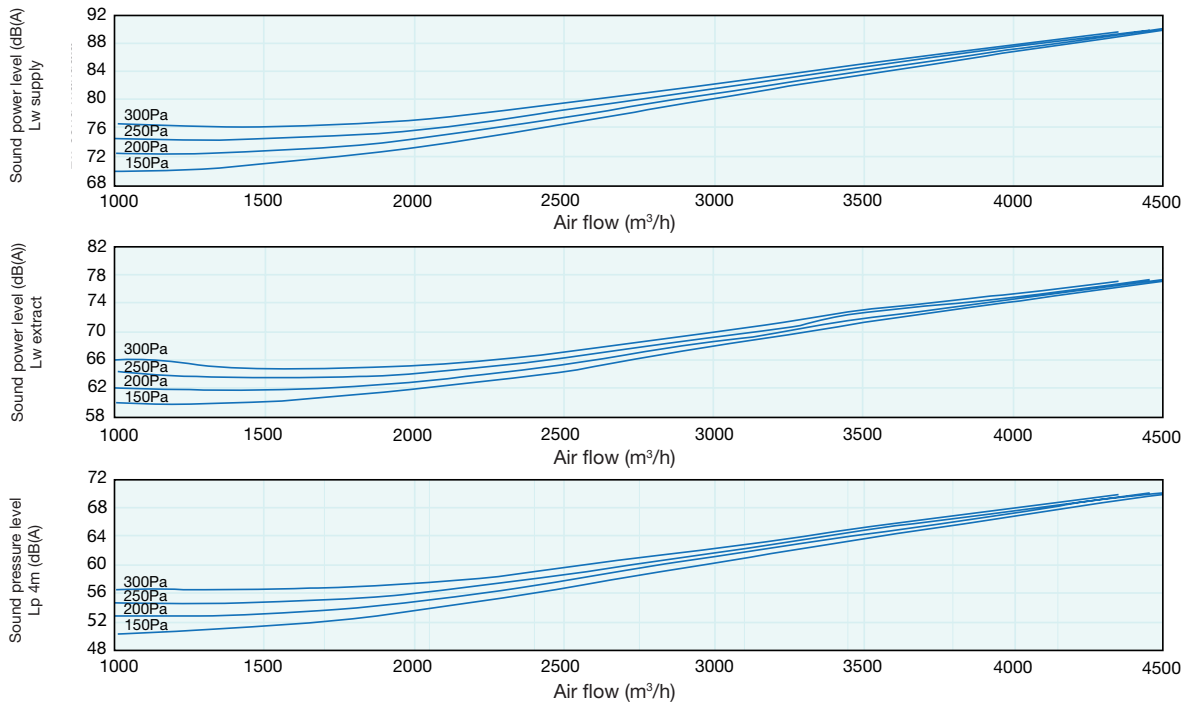

VORT NRG 6000 EC - EC EH

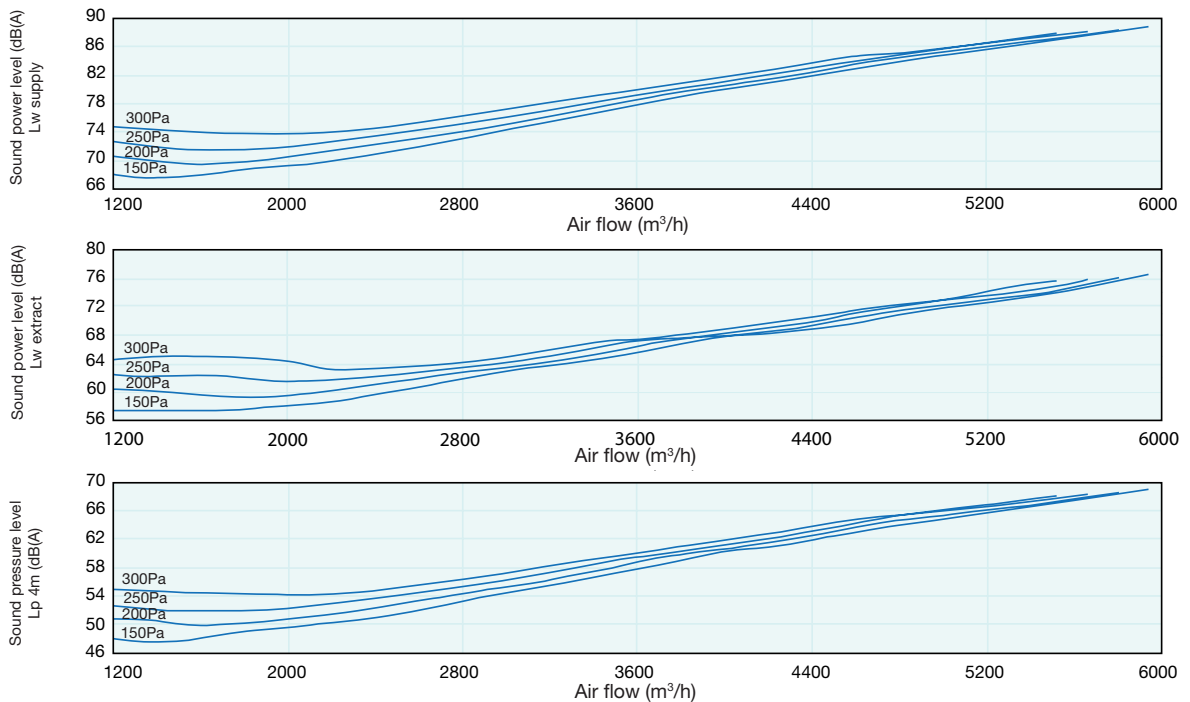



VORT NRG EC RANGE

Heat recovery units equipped with static heat exchangers characterized by high levels of heat exchange efficiency, top performances consumptions

NOISE EMISSIONS

VORT NRG 8000 EC - EC EH

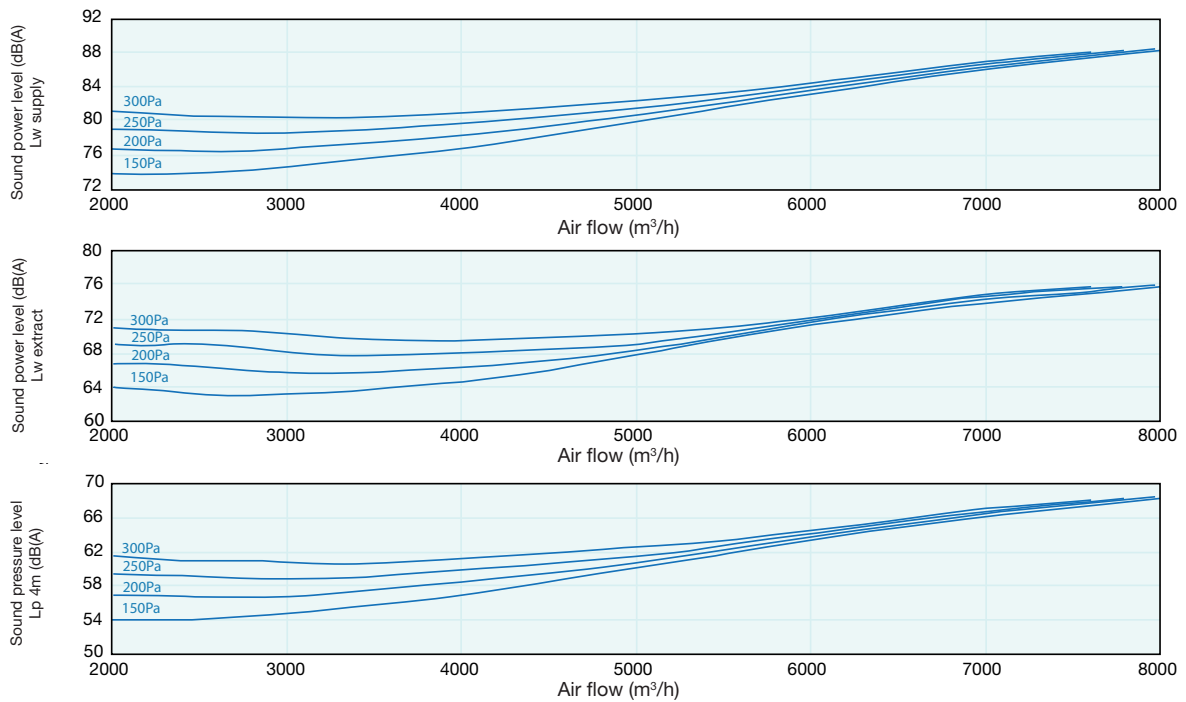

ACCESSORIES

Description	Code	Product
POTI NRG Remote speed control potentiometer for one or both fans	21039	VORT NRG EC all models
TOUCH LCD CP Control panel with touch LCD display	21025	VORT NRG EC EH all models
NRG EC RRC H 3000 Rain canopy, steel with lacquered finish	21026	Per VORT NRG EC - EC EH 3000 (horizontal installation)
NRG EC RRC H 4500 Rain canopy, steel with lacquered finish	21027	Per VORT NRG EC - EC EH 4500 (horizontal installation)
NRG EC RRC V 6000 Rain canopy, steel with lacquered finish	21028	Per VORT NRG EC - EC EH 6000 (horizontal installation)
NRG EC RRC H 8000 Rain canopy, steel with lacquered finish	21029	Per VORT NRG EC - EC EH 8000 (horizontal installation)
NRG EC RRC V 3000 Rain canopy, steel with lacquered finish	21081	Per VORT NRG EC - EC EH 3000 (installazione verticale)
NRG EC RRC V 4500 Rain canopy, steel with lacquered finish	21082	Per VORT NRG EC - EC EH 4500 (vertical installation)
NRG EC RRC V 6000 Rain canopy, steel with lacquered finish	21083	Per VORT NRG EC - EC EH 6000 (vertical installation)
NRG EC RRC V 8000 Rain canopy, steel with lacquered finish	21084	Per VORT NRG EC 8000 (can be installed vertically)
NRG EC RRO 3000 Rain cowl, galvanized sheet steel with anti-bird protective safety mesh	21076	VORT NRG EC - EC EH 3000
NRG EC RRO 4500 Rain canopy, galvanized sheet steel with anti-bird protective safety mesh	21077	VORT NRG EC - EC EH 4500
NRG EC RRO 6000 Rain cowl, galvanized sheet steel with anti-bird protective safety mesh	21078	VORT NRG EC - EC EH 6000
NRG EC RRO 8000 Rain cowl, galvanized sheet steel with anti-bird protective safety mesh	21079	VORT NRG EC - EC EH 8000
NRG EC 4F Set of 4 feet, height 90 mm	21037	VORT NRG EC - EC EH 600 - 800
NRG EC 6F Set of 6 feet, height 90 mm	21038	VORT NRG EC - EC EH 1500 - 2000 - 2500 - 3000 - 4500 - 6000
NRG EC 250 FPD Motorized round damper rated IPX4, for protection against frost Ø 250 mm	21056	VORT NRG EC - EC EH 600
NRG EC 315 FPD Motorized round damper rated IPX4, for protection against frost Ø 315 mm	21057	VORT NRG EC - EC EH 800
NRG EC 355 FPD Motorized round damper rated IPX4, for protection against frost Ø 355 mm	21058	VORT NRG EC - EC EH 1500
NRG EC 400 FPD Motorized round damper rated IPX4, for protection against frost Ø 400 mm	21059	VORT NRG EC - EC EH 2000
NRG EC 450 FPD Motorized round damper rated IPX4, for protection against frost Ø 450 mm	21080	VORT NRG EC - EC EH 2500



VORT NRG ECR RANGE

Heat recovery units equipped with rotary heat exchangers characterized by high levels of heat exchange efficiency, top performances and low consumptions



COMPOSITION OF THE RANGE

The NEW RANGE of **VORT NRG ECR** heat recovery units is made up of 6 models (air flow rates between 100 m³/h and 3550 m³/h), each available in two versions:

VORT NRG ECR, suitable for use with outdoor temperatures down to -5 °C.

VORT NRG ECR EH, equipped with automatically controlled electric post-heating coils, suitable for operation with outdoor temperatures down to -20 °C.

The composition of the new **VORT NRG ECR** series is indicated below:

Products	Code
VORT NRG 600 ECR	45399
VORT NRG 800 ECR	45400
VORT NRG 1500 ECR	45401
VORT NRG 2000 ECR	45402
VORT NRG 2500 ECR	45403
VORT NRG 3000 ECR	45404

Products	Code
VORT NRG 600 ECR EH	45405
VORT NRG 800 ECR EH	45406
VORT NRG 1500 ECR EH	45407
VORT NRG 2000 ECR EH	45408
VORT NRG 2500 ECR EH	45409
VORT NRG 3000 ECR EH	45410

SPECIAL VERSIONS OF EACH MODEL, AVAILABLE ON REQUEST, INCLUDE:

- advanced electronics, compatible with the management of external devices such as post-heating coils (electric or hydronic), hydronic post-cooling coils (**FIRST** versions).
- a hydronic post-heating coil (**PREMIUM BC** versions)
- an electric post-heating coil (**PREMIUM BE** versions)
- Constant pressure fan control (**LOBBY** versions)
- Constant flow fan control (**MAC2** versions)
- Automatic modulation of flow rates of fresh air supply and stale air, between two preset limits that remain constant with variations in back pressure, in response to the concentration of CO₂ in the connected rooms (**QUATTRO** versions)



FEATURES OF CONSTRUCTION

- Cabinet frame fabricated from rounded aluminium sections; moulded nylon spacers incorporated to provide thermal break; sandwich panels with 10/10 gauge skins (inner: zinc-coated steel; outer: steel with RAL 7035 paint finish and protective film) and high density rock wool insulation layer (M0), thickness 25 mm in models 600 and 800, thickness 50 mm in models 1500, 2000, 2500 and 3000.
- 2-speed, ball bearing external rotor EC motors (speeds independently adjustable during installation) directly coupled to backward curved centrifugal impellers, capable of ensuring air flow rates up to 3550 m³/h in conjunction with low noise levels.
- Air-to air, aluminium made, rotary heat exchanger granting with Eurovent-certified efficiency better than 80% based on European standard EN 308. The heat exchange efficiency of the new VORT NRG ECR appliances exceeds the most stringent requirements of EU regulation 1253/2014, Tier 2, to be implemented January 2018.
- Circular ports with lip seals guaranteeing airtight flow passage.
- Filters, G4 in the stale air extraction duct, F7 in the fresh air supply duct, both installed upstream of internal components to guarantee their protection, mounted on slide ways (for ease of removal), and fitted with lip seals to ensure a completely airtight fit.
- Condition of filters constantly monitored by a differential pressure switch with automatic alert generated when maintenance or replacement is due.
- Dedicated cabinet panels with lock and key closure, providing direct access to filters and internal components.
- Fixed panel, accessible from the top of the cabinet, incorporating proximity switch with lock, fan speed control potentiometers and cable glands.
- Brackets incorporated into the cabinet structure, for anchorage to floor.
- Local switch mounted at the top of the cabinet; to shut off the unit in the event of breakdown.
- Installation and initial configuration simplified by plug-and-play design.
- Vertical installation; inlet and outlet ports grouped at the top of the appliance, together with minimal depth dimensions of **VORT NRG ECR** range, facilitated installation in equipment rooms.
- Built-in electric post-heaters, automatically controlled (EH versions).
- Advanced controls (**EH** versions), including remote wired control panels connected by wire, complete with touch LCD screen and allowing for integration into Building Management Systems; Free-heating and Night-cooling functions also provided.



VORT NRG ECR RANGE

Heat recovery units equipped with rotary heat exchangers characterized by high levels of heat exchange efficiency, top performances and low consumptions

CONTROLS AND SAFETY DEVICES

- **VORT NRG ECR** models are equipped with potentiometers by way of which the speed of the two fans can be controlled independently.
- **VORT NRG ECR EH** models incorporate advanced electronics including a control housing with LCD display, connected by wire (maximum distance 100 m), which allows:
 - Independent control of fan speeds
 - Weekly programming of operating mode (control software includes a calendar with public holidays and vacations covered).
 - Check on the condition of filters and indication of the need for maintenance or replacement.
 - Setting of machine emergency response mode in the event of fire; there are 5 different settings provided, selectable at the moment of installation.
- **“STOP”** both fans cease operation
- **“ON”** the fans start up or continue operating at maximum speed-all other alarms are ignored.
- **“AUTO”** the unit continues to operate on the basis of the setting (OFF, low speed, high speed) selected previously.
- **“SUPPLY ONLY”**: the fan on the supply air side is made to run at maximum speed, whilst the fan in the extraction duct is shut down.
- **“EXTRACT ONLY”**: the fan on the stale air extraction side is made to run at maximum speed, whilst the fan in the supply air duct is shut down.
- To enable these operating modes, each **VORT NRG ECR EH** heat recovery unit incorporates a digital “external stop” contact allowing the connection of a manual switch: if available and wired up, this switch will always have priority over the fire emergency response operating modes.
- The air flow through each fan is permanently monitored by a dedicated pressure switch; any faults detected are indicated, in the case of **VORT NRG EC EH** versions, on the display of the control panel (in the case of **VORT NRG ECR** versions, a voltage free contact is available for the connection of an external indicator device).
- The machine can be shut down in emergencies by means of a local switch, mounted on the cabinet of all models, which is padlockable to prevent unauthorized access.

GENERAL SPECIFICATIONS

Equipmen	VORT NRG ECR Range	VORT NRG ECR EH Range
Two speed low energy EC fan unit: speeds independently adjustable	•	•
F7 filter on fresh air supply duct	•	•
G4 filter on stale air extraction duct	•	•
Rotary heat exchanger delivering high efficiency (>80%), certified by Eurovent	•	•
Variable speed rotary heat exchanger	-	•
Angled tray for collection and drainage of condensate	•	•
Sandwich panels 25 mm thick, with high density rock wool insulation layer and RAL 7035 finish	(600 - 800 models)	(600 - 800 Range)
Sandwich panels 50 mm thick, with high density rock wool insulation layer and RAL 7035 finish	(1500 - 2000 - 2500 - 3000 models)	(1500 - 2000 - 2500 - 3000 models)
Circular connection ports with lip seals	•	•
Remote wired control panel (up to 100 m), with touch LCD display	-	•
Communication module for integration into BMS (protocols: MODBUS RS485, BACNET TCP/IP and WEB selectable in alternation from menu)	-	•
Minimum and Maximum fan speeds controlled from panel	-	•
PPotentiometers for independent setting of fan speed	•	-
Temperature sensor in supply air duct	-	•
Temperature sensor in extraction air duct	-	•
Outdoor temperature sensor	•	•
Safety thermostat on electric post-heating coil	-	•
Rotary heat exchanger motion sensor	•	•
Lockable proximity switch	•	•
Power cable gland	•	•
Functions	VORT NRG ECR Range	VORT NRG ECR EH Range
Automatically controlled electric post-heating coil	-	•
Free-cooling function	•	•
Free-heating function	-	•
Night-cooling function (extra ventilation)	-	•
Optimized management of cooling energy recovery	-	•
Thermostat-controlled management of cooling energy recovery (adjustable)	•	-
Optimized management of heating energy recovery	-	•
Thermostat-controlled management of heating energy recovery (adjustable)	•	-
Fresh air temperature management	-	•
Return air temperature management	-	•
Weekly clock	-	•
Vacation and public holidays clock	-	•
Differential pressure switch monitoring filter in supply air duct	•	•
Pressure switches monitoring supply and extract air flows	•	•
System response modes in the event of fire (5 options)	-	•
Management of dehumidifier module	-	•
Accessories installable on site	VORT NRG ECR range	VORT NRG ECR EH Range
Dehumidifier module	-	*

* Optional not fitted

• Standard equipment

- Not available

VORT NRG ECR RANGE

Heat recovery units equipped with rotary heat exchangers characterized by high levels of heat exchange efficiency, top performances and low consumptions

DIMENSIONS MODELS 600-800-1500-2000-2500

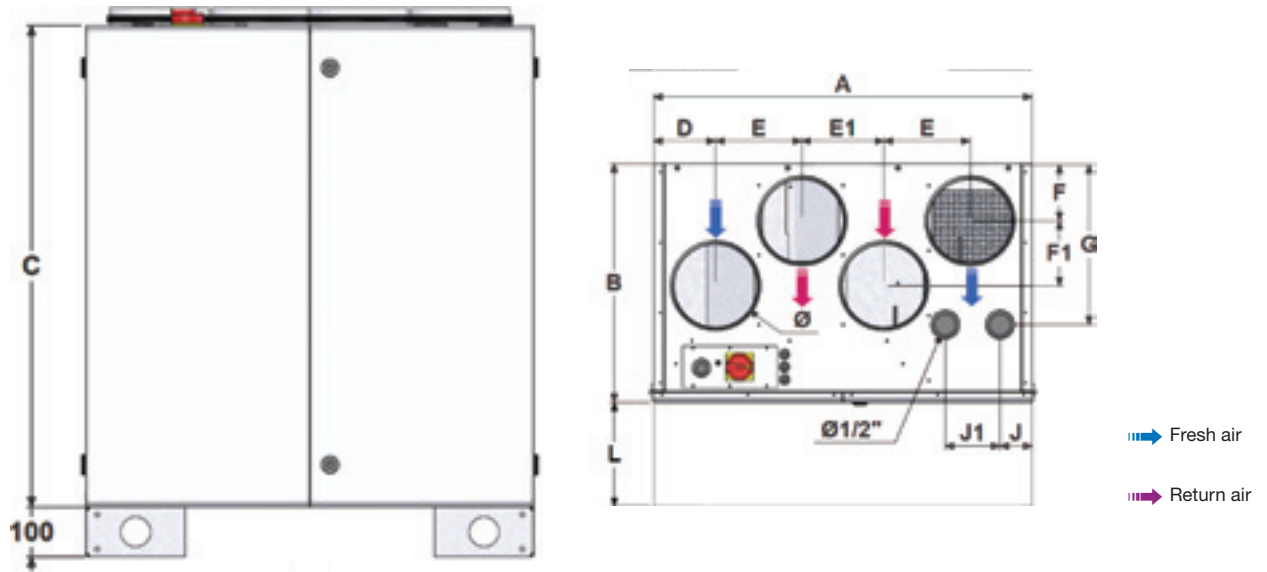

Models	Ø	A	B	C	D	E	E1	E2	F	F1	G	J	J1	L
VORT NRG 600 ECR VORT NRG 600 ECR EH	200	900	570	970	148	205	195	205	135	155	390	75	130	520
VORT NRG 800 ECR VORT NRG 800 ECR EH	250	1020	700	1050	173	225	225	225	160	235	490	75	180	650
VORT NRG 1500 ECR VORT NRG 1500 ECR EH	315	1400	750	1100	230	315	310	315	210	185	585	100	230	720
VORT NRG 2000 ECR VORT NRG 2000 ECR EH	355	1500	830	1220	250	335	330	335	230	235	655	100	230	770
VORT NRG 2500 ECR VORT NRG 2500 ECR EH	400	1610	920	1420	273	355	355	355	250	285	755	100	230	820
VORT NRG 3000 ECR VORT NRG 3000 ECR EH	450	1730	1085	1420	300	365	370	400	275	390	795	100	305	980

Dimensions (mm)

TECHNICAL DATA

Models	Code	Max air flow (m ³ /h)	Pre heater power (kW)	Fans					Electrical power supply				Kg
				Rated power of motors (W)	Operating temperature (°C)	IP class	Insulation class	Thermal overload protection (*)	Voltage (V)	N° phases	Frequency (Hz)	Protection current (A)	
VORT NRG 600 ECR	45399	750	-	2x169	- 20 / + 60	IP54	B	PTI	230	1	50	3,8	130
VORT NRG 800 ECR	45400	1000	-	2x220	- 20 / + 60	IP44	B	PTI	230	1	50	4,1	170
VORT NRG 1500 ECR	45401	1850	-	2x480	- 20 / + 40	IP54	B	PTI	230	1	50	5,3	225
VORT NRG 2000 ECR	45402	2375	-	2x750	- 20 / + 40	IP54	B	PTI	230	1	50	7,6	270
VORT NRG 2500 ECR	45403	3500	-	2x1.000	- 20 / + 50	IP54	B	PTI	400	3+N	50	4,3	345
VORT NRG 3000 ECR	45404	4000	-	2x1.000	- 20 / + 50	IP54	B	PTI	400	3+N	50	4,3	420
VORT NRG 600 ECR EH	45405	700	2,5	2x169	- 20 / + 60	IP54	B	PTI	230	1	50	14,7	135
VORT NRG 800 ECR EH	45406	950	3,75	2x220	- 20 / + 60	IP44	B	PTI	230	1	50	20,4	175
VORT NRG 1500 ECR EH	45407	1800	5,25	2x480	- 20 / + 40	IP54	B	PTI	230	1	50	28,1	232
VORT NRG 2000 ECR EH	45408	2300	10,5	2x750	- 20 / + 40	IP54	B	PTI	400	3+N	50	18,5	278
VORT NRG 2500 ECR EH	45409	3200	13,5	2x1.000	- 20 / + 50	IP54	B	PTI	400	3+N	50	23,8	355
VORT NRG 3000 ECR EH	45410	3750	16,5	2x1.000	- 20 / + 50	IP54	B	PTI	400	3+N	50	28,1	432

(*) Built-in thermal cutout



VORT NRG ECR RANGE

Heat recovery units equipped with rotary heat exchangers characterized by high levels of heat exchange efficiency, top performances and low consumptions

ENERGY DATA

	Models	Unit of measure	VORT NRG 600 ECR	VORT NRG 800 ECR	VORT NRG 1500 ECR
	Code		45399	45400	45401
Supplier's name or trade mark	-		Vortice	Vortice	Vortice
Declared typology	-		UVNR-B**	UVNR-B**	UVNR-B**
Type of drive	-		VSD***	VSD***	VSD***
Type of heat recovery system HRS	-		other	other	other
Thermal efficiency of heat recovery	%		78.9	80.8	75.9
Nominal NRVU flow rate	m ³ /s		0.1600	0.2400	0.3400
Effective electric power input	kW		0.180	0.250	0.520
SFPint ****	W/(m ³ /s)		1337	1412	1252
Face velocity at design flow rate	m/s		1.04	1.10	1.54
Nominal external pressure (Δps, ext)	Pa		203	132	459
Internal pressure drop of ventilation components (Δps, int)	Pa		209	188	217
Internal pressure drop of non-ventilation components (Δps, add)	Pa		NA*	NA*	NA*
Static efficiency of fans used in accordance with Regulation (EU) N. 327/2011	%		49.2	40.7	54.7
Declared maximum internal leakage rate of the casing of ventilation units	%		NA*	NA*	NA*
Declared maximum external leakage rate of the casing of ventilation units	%		2.5	2.4	2.3
Energy performance energy or classification of the filters	-		NA*	NA*	NA*
Description of visual filter warning	-		See instruction manual	See instruction manual	See instruction manual
Casing sound power level (LWA)	dB(A)		57	59	63

	Models	Unit of measure	VORT NRG 2000 ECR	VORT NRG 2500 ECR	VORT NRG 3000 ECR
	Code		45402	45403	45404
Supplier's name or trade mark	-		Vortice	Vortice	Vortice
Declared typology	-		UVNR-B**	UVNR-B**	UVNR-B**
Type of drive	-		VSD***	VSD***	VSD***
Type of heat recovery system HRS	-		other	other	other
Thermal efficiency of heat recovery	%		79.8	79.8	79.6
Nominal NRVU flow rate	m ³ /s		0.3800	0.5400	0.8900
Effective electric power input	kW		0.770	0.980	1.120
SFPint ****	W/(m ³ /s)		1365	1340	1284
Face velocity at design flow rate	m/s		1.28	1.32	1.81
Nominal external pressure (Δps, ext)	Pa		642	559	343
Internal pressure drop of ventilation components (Δps, int)	Pa		191	200	243
Internal pressure drop of non-ventilation components (Δps, add)	Pa		NA*	NA*	NA*
Static efficiency of fans used in accordance with Regulation (EU) N. 327/2011	%		49.0	59.0	58.8
Declared maximum internal leakage rate of the casing of ventilation units	%		NA*	NA*	NA*
Declared maximum external leakage rate of the casing of ventilation units	%		2.7	2.3	1.6
Energy performance energy or classification of the filters	-		NA*	NA*	NA*
Description of visual filter warning	-		See instruction manual	See instruction manual	See instruction manual
Casing sound power level (LWA)	dB(A)		70	68	63

* NA: Not applicable.

** UVNR-B: Non Residential Ventilation units - Bidirectional.

*** VSD: Multiple speed.

**** SFPint: Specific power of the internal components of the ventilation.

ENERGY DATA

	Models	Unit of measure	VORT NRG 600 ECR EH	VORT NRG 800 ECR EH	VORT NRG 1500 ECR EH
	Code		45405	45406	45407
Supplier's name or trade mark	-		Vortice	Vortice	Vortice
Declared typology	-		UVNR-B**	UVNR-B**	UVNR-B**
Type of drive	-		VSD***	VSD***	VSD***
Type of heat recovery system HRS	-		other	other	other
Thermal efficiency of heat recovery	%		78.9	80.8	75.9
Nominal NRVC flow rate	m ³ /s		0.1600	0.2400	0.3400
Effective electric power input	kW		0.180	0.250	0.520
SFPint ****	W/(m ³ /s)		1337	1412	1252
Face velocity at design flow rate	m/s		1.04	1.10	1.54
Nominal external pressure (Δp_s , ext)	Pa		203	132	459
Internal pressure drop of ventilation components (Δp_s , int)	Pa		209	188	217
Internal pressure drop of non-ventilation components (Δp_s , add)	Pa		NA*	NA*	NA*
Static efficiency of fans used in accordance with Regulation (EU) N. 327/2011	%		49.2	40.7	54.7
Declared maximum internal leakage rate of the casing of ventilation units	%		NA*	NA*	NA*
Declared maximum external leakage rate of the casing of ventilation units	%		2.5	2.4	2.3
Energy performance energy or classification of the filters	-		NA*	NA*	NA*
Description of visual filter warning	-		See instruction manual	See instruction manual	See instruction manual
Casing sound power level (LWA)	dB(A)		57	59	63

	Models	Unit of measure	VORT NRG 2000 ECR EH	VORT NRG 2500 ECR EH	VORT NRG 3000 ECR EH
	Code		45408	45409	45410
Supplier's name or trade mark	-		Vortice	Vortice	Vortice
Declared typology	-		UVNR-B**	UVNR-B**	UVNR-B**
Type of drive	-		VSD***	VSD***	VSD***
Type of heat recovery system HRS	-		other	other	other
Thermal efficiency of heat recovery	%		79.8	79.8	79.6
Nominal NRVC flow rate	m ³ /s		0.3800	0.5400	0.8900
Effective electric power input	kW		0.770	0.980	1.120
SFPint ****	W/(m ³ /s)		1365	1340	1284
Face velocity at design flow rate	m/s		1.28	1.32	1.81
Nominal external pressure (Δp_s , ext)	Pa		642	559	343
Internal pressure drop of ventilation components (Δp_s , int)	Pa		191	200	243
Internal pressure drop of non-ventilation components (Δp_s , add)	Pa		NA*	NA*	NA*
Static efficiency of fans used in accordance with Regulation (EU) N. 327/2011	%		49.0	59.0	58.8
Declared maximum internal leakage rate of the casing of ventilation units	%		NA*	NA*	NA*
Declared maximum external leakage rate of the casing of ventilation units	%		2.7	2.3	1.6
Energy performance energy or classification of the filters	-		NA*	NA*	NA*
Description of visual filter warning	-		See instruction manual	See instruction manual	See instruction manual
Casing sound power level (LWA)	dB(A)		70	68	63

* NA: Not applicable.

** UVNR-B: Non Residential Ventilation units - Bidirectional.

*** VSD: Multiple speed.

**** SFPint: Specific power of the internal components of the ventilation.



VORT NRG ECR RANGE

Heat recovery units equipped with rotary heat exchangers characterized by high levels of heat exchange efficiency, top performances and low consumptions

PERFORMANCE AND ENERGY USAGE

VORT NRG 600 ECR - ECR EH

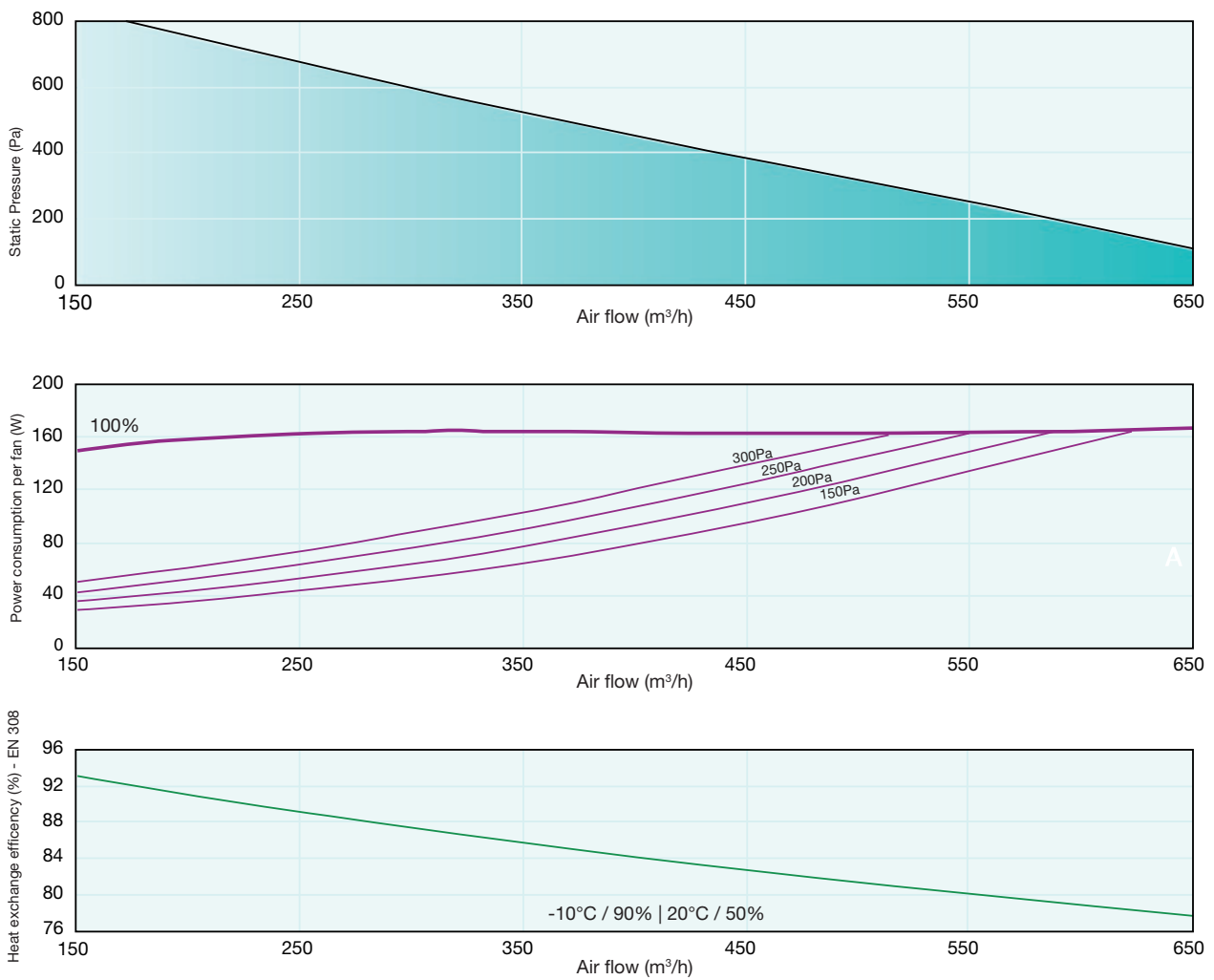

PERFORMANCE AND ENERGY USAGE

VORT NRG 800 ECR - ECR EH

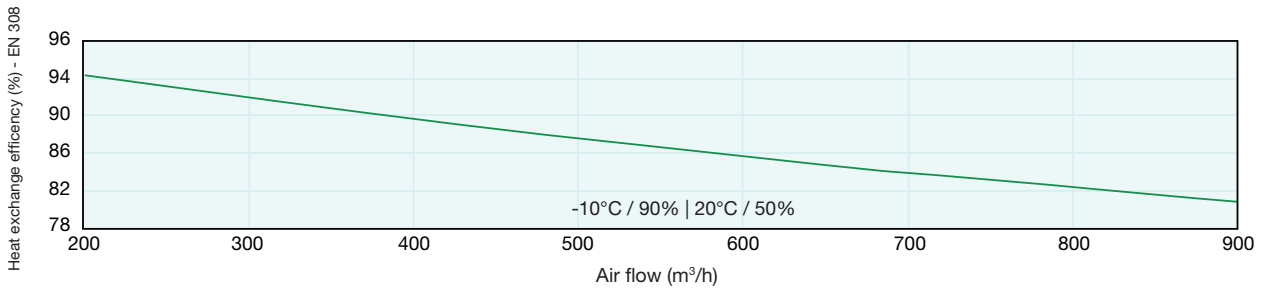
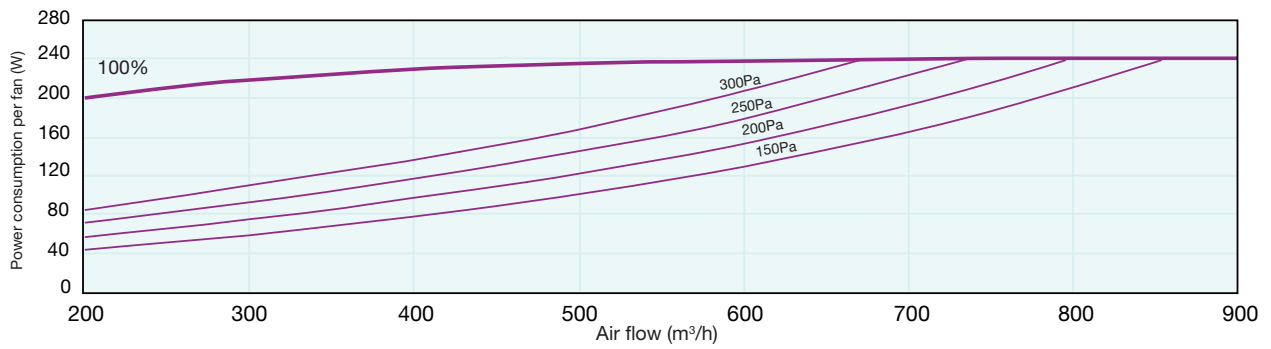
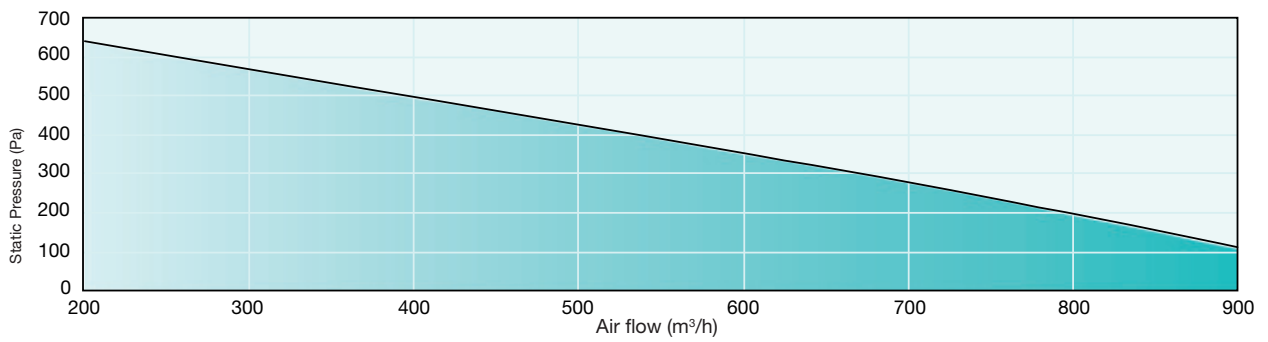



VORT NRG ECR RANGE

Heat recovery units equipped with rotary heat exchangers characterized by high levels of heat exchange efficiency, top performances and low consumptions

PERFORMANCE AND ENERGY USAGE

VORT NRG 1500 ECR - ECR EH

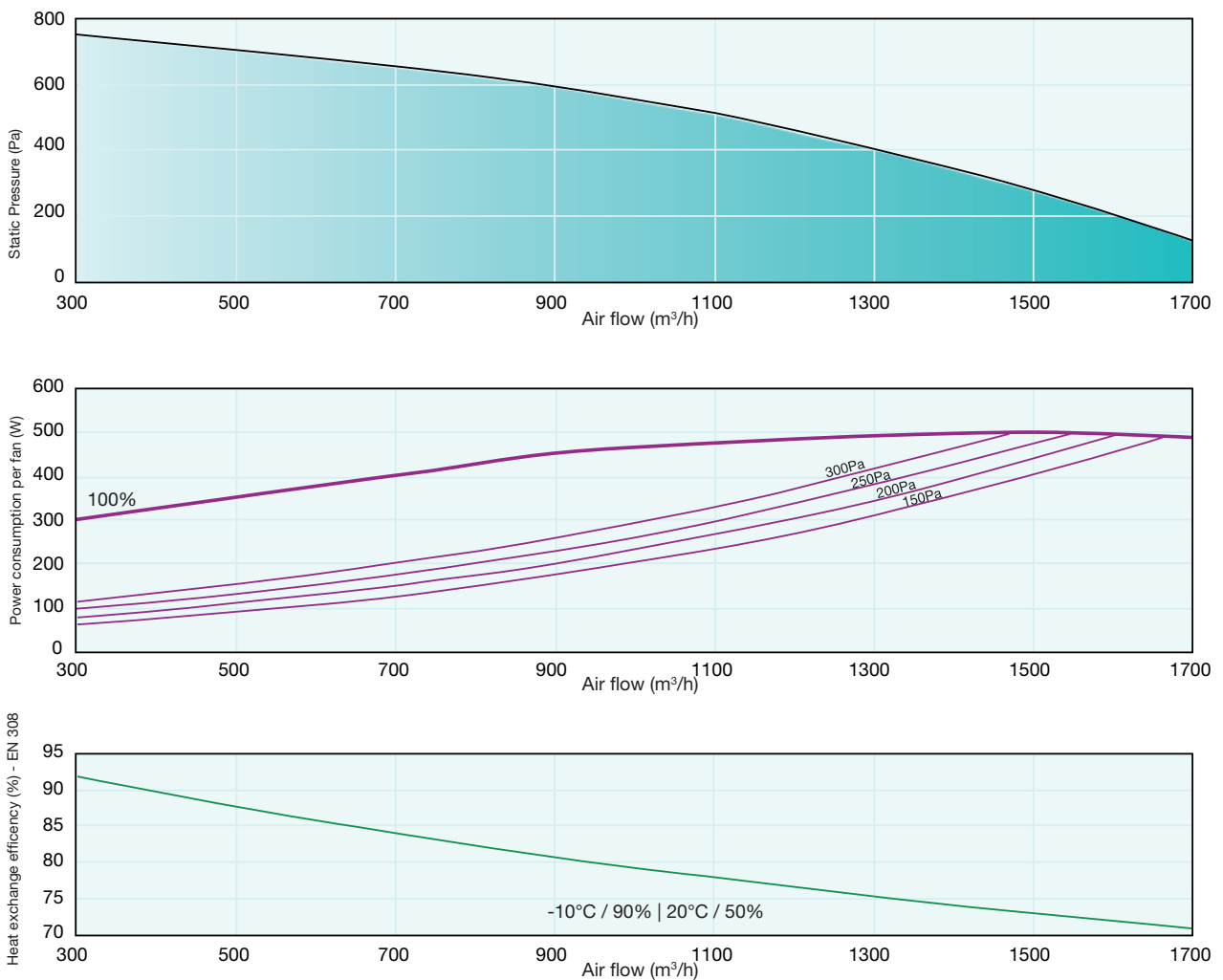

PERFORMANCE AND ENERGY USAGE

VORT NRG 2000 ECR - ECR EH

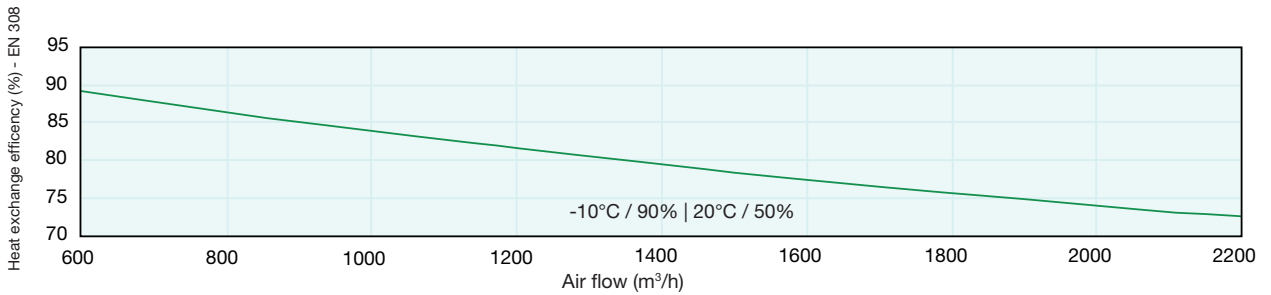
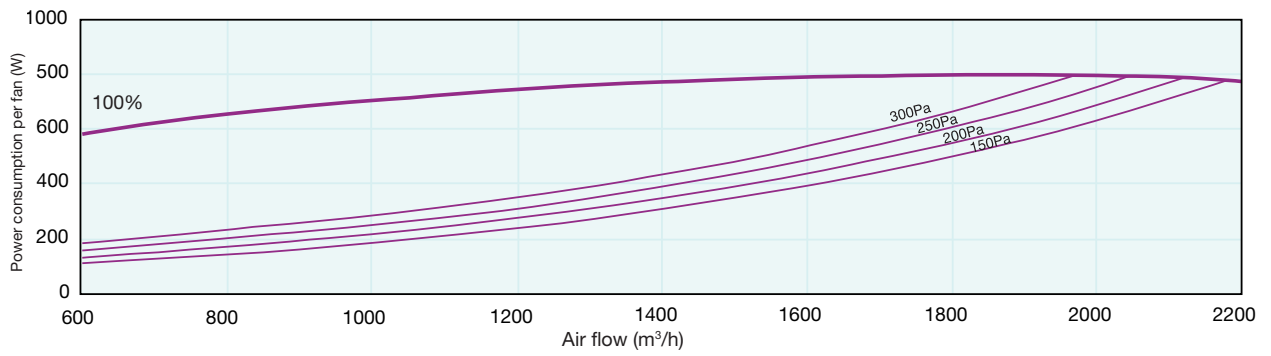
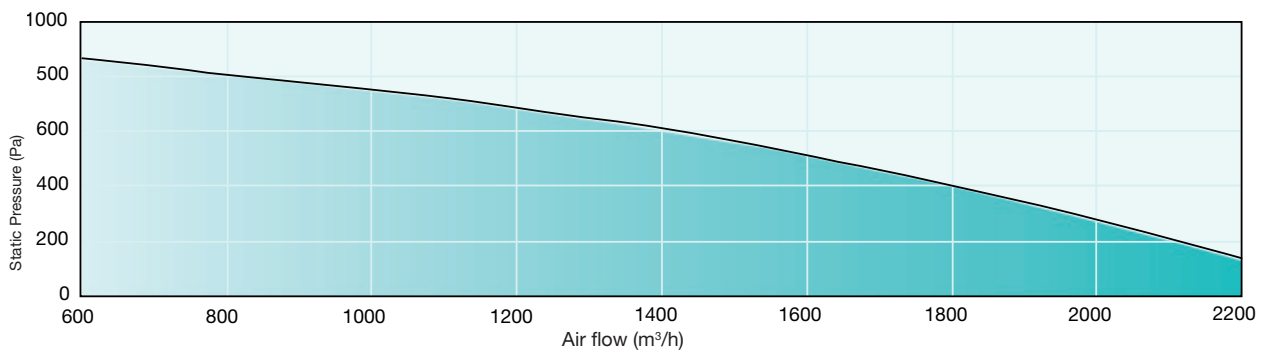



VORT NRG ECR RANGE

Heat recovery units equipped with rotary heat exchangers characterized by high levels of heat exchange efficiency, top performances and low consumptions

PERFORMANCE AND ENERGY USAGE

VORT NRG 2500 ECR - ECR EH

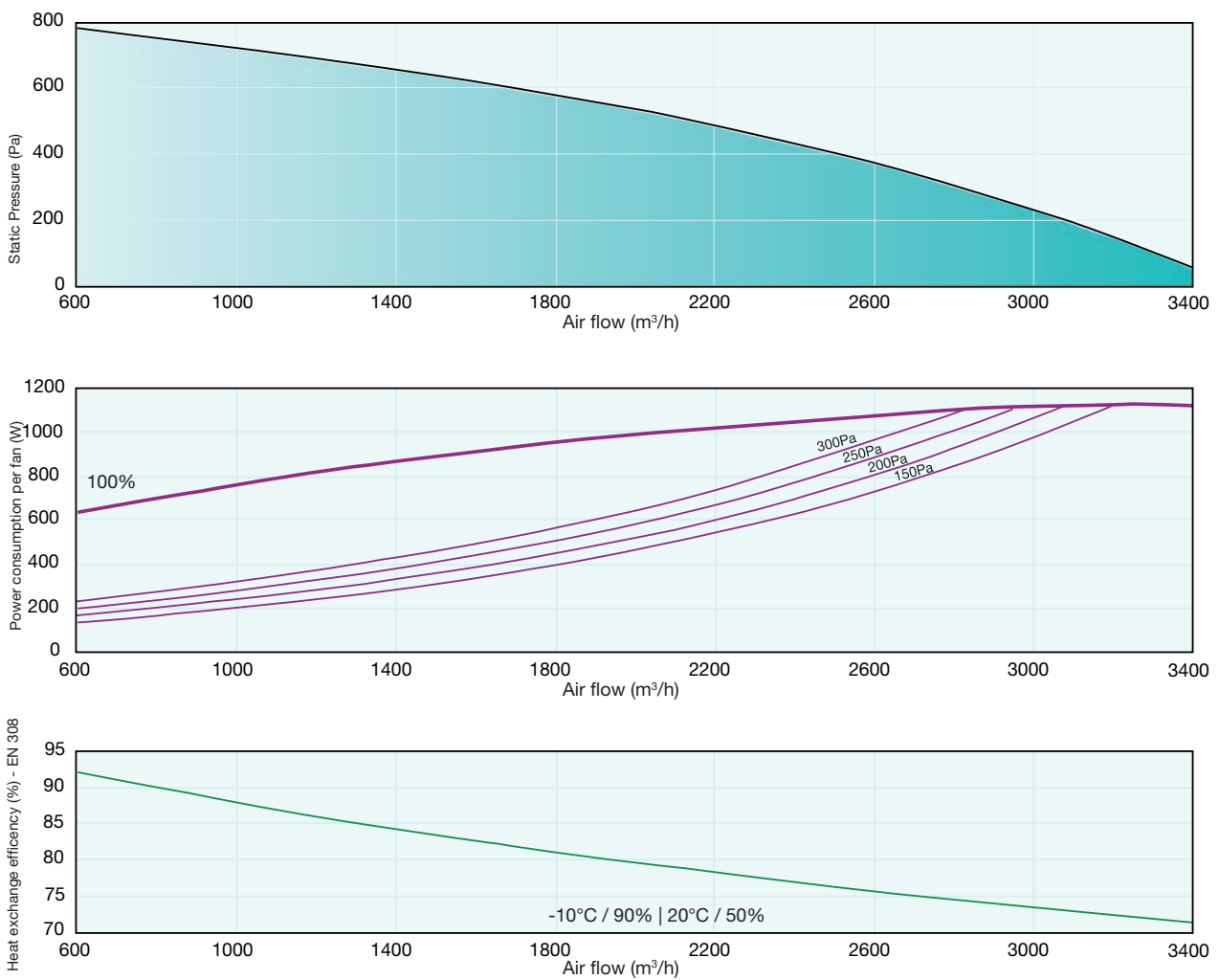

PERFORMANCE AND ENERGY USAGE

VORT NRG 3000 ECR - ECR EH

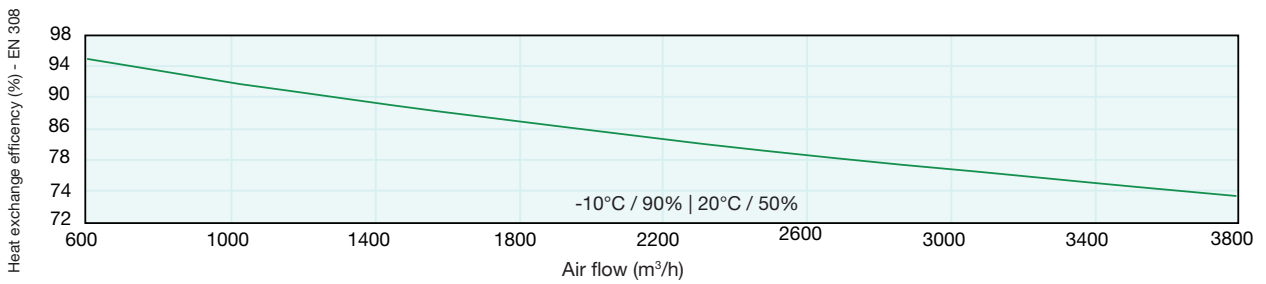
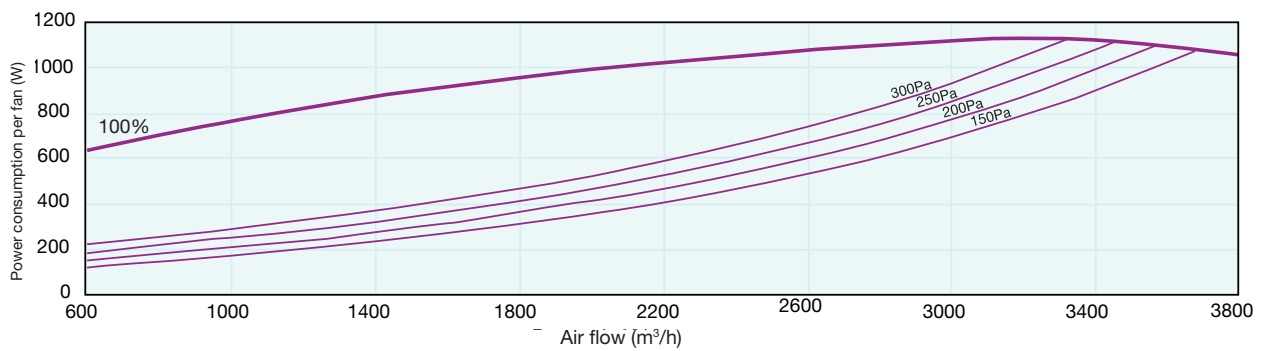
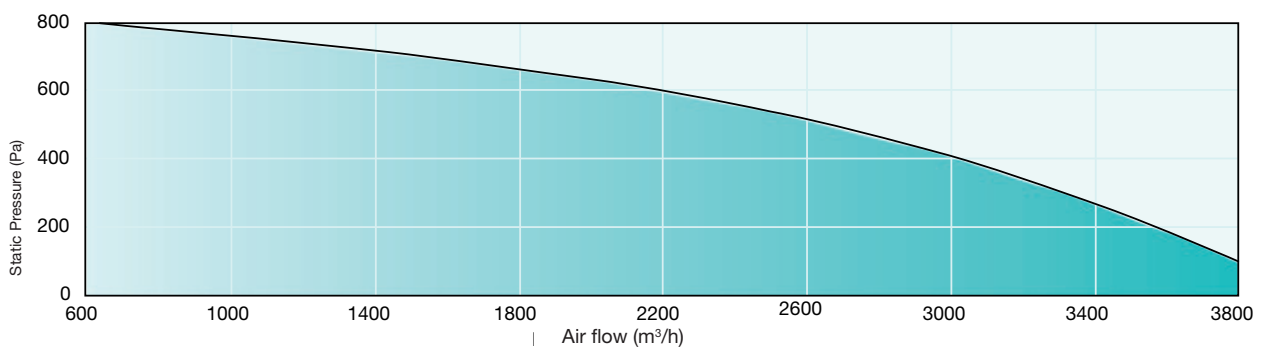

VORT NRG ECR RANGE

Heat recovery units equipped with rotary heat exchangers characterized by high levels of heat exchange efficiency, top performances and low consumptions

NOISE EMISSIONS

The “**Lp4m**” curves indicate the sound pressure level measured at 4m in free field conditions, with hemispherical distribution on a reflecting plane, leaving the ports of the appliance unconnected on the “outdoors” side (“fresh air intake” and “stale air extract”) and connecting the ports on the “indoors” side (“fresh air supply” and “stale air extract”).

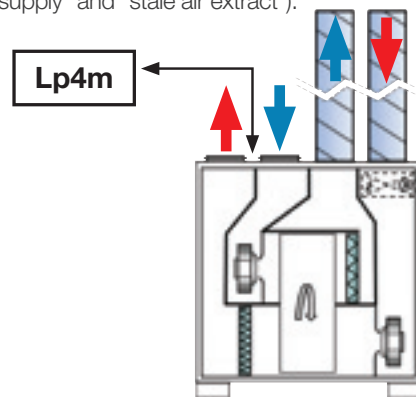

To obtain the overall sound pressure level **Lp** in dB(A) at a different distance, add the following values to the data indicated by the **Lp_{4m}** curves:

Distance (m)	1,5	3	4	5	7	10
Weighting on the basis of distance dB(A)	9	3	0	-2	-5	-8

To obtain sound pressure level NSC4 dB(A) (sound pressure measured at 4 m in free field conditions with hemispherical distribution, placing the appliance on a reflecting plane, with inlet and outlet ports connected to ducts having the same sound insulation properties), add the data tabulated below to the “**Lp4m**” values indicated by the curves.

Weighting required to obtain the NSC4 db(A) value on the basis of the Lp4m indicated by the curve	
VORT NRG 600 ECR/ECR EH	-18
VORT NRG 800 ECR/ECR EH	-18
VORT NRG 1500 ECR/ECR EH	-19
VORT NRG 2000 ECR/ECR EH	-20
VORT NRG 2500 ECR/ECR EH	-20
VORT NRG 3000 ECR/ECR EH	-21

The “**Lw supply dB(A)**” curves correspond to overall sound power radiated in the vicinity of the two ports “**fresh air supply**” and “**stale air extract**”. To obtain the **Lw** sound power spectrum at the sides of the “**fresh air supply**” or “**stale air extract**” ports, add the values tabulated below to the “**Lw supply**” sound power data indicated by the curves.

Weighting of downstream sound spectrum of “ Lw supply dB(A) ” indicated by the curves								
Frequency	63 Hz	125 Hz	250 Hz	500 Hz	1000 Hz	2000 Hz	4000 Hz	8000 Hz
VORT NRG 600 ECR/ECR EH	-22	-14	-9	-6	-6	-8	-12	-12
VORT NRG 800 ECR/ECR EH	-18	-8	-7	-7	-7	-9	-16	-20
VORT NRG 1500 ECR/ECR EH	-20	-11	-6	-8	-6	-9	-14	-19
VORT NRG 2000 ECR/ECR EH	-20	-15	-9	-8	-6	-6	-13	-17
VORT NRG 2500 ECR/ECR EH	-23	-14	-8	-9	-5	-7	-11	-15
VORT NRG 3000 ECR/ECR EH	-26	-18	-12	-10	-4	-6	-10	-13

NOISE EMISSIONS

The “**Lw extract duct dB(A)**” curves correspond to overall sound power radiated in the vicinity of the two ports “**stale air extract**” and “**fresh air intake**”.

To obtain the **Lw** sound power spectrum at the sides of the “**stale air extract**” or “**fresh air intake**” ports, add the values tabulated below to the “**Lw extract**” sound power data indicated by the curves.

Weighting of upstream sound spectrum of “ Lw extract duct dB(A) ” indicated by the curves								
Frequency	63 Hz	125 Hz	250 Hz	500 Hz	1000 Hz	2000 Hz	4000 Hz	8000 Hz
VORT NRG 600 ECR/ECR EH	-33	-24	-13	-7	-5	-5	-12	-15
VORT NRG 800 ECR/ECR EH	-22	-12	-7	-5	-6	-10	-16	-24
VORT NRG 1500 ECR/ECR EH	-21	-14	-7	-6	-6	-8	-13	-21
VORT NRG 2000 ECR/ECR EH	-26	-19	-8	-5	-6	-8	-12	-20
VORT NRG 2500 ECR/ECR EH	-26	-16	-7	-6	-8	-6	-12	-18
VORT NRG 3000 ECR/ECR EH	-30	-19	-9	-7	-7	-5	-10	-16

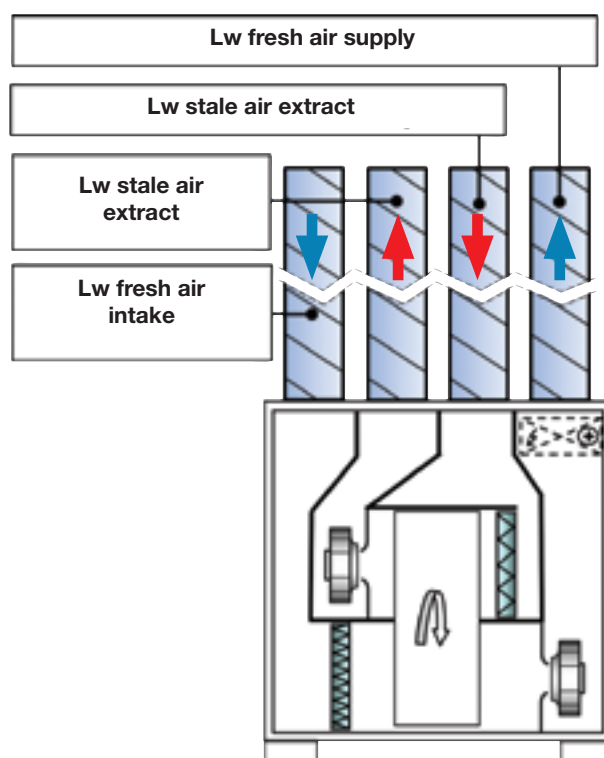

Tolerances:

Overall values: +/- 3 dB(A)

Sound spectrum: +/- 5 dB(A)



VORT NRG ECR RANGE

Heat recovery units equipped with rotary heat exchangers characterized by high levels of heat exchange efficiency, top performances and low consumptions

NOISE EMISSIONS

VORT NRG 600 ECR - ECR EH

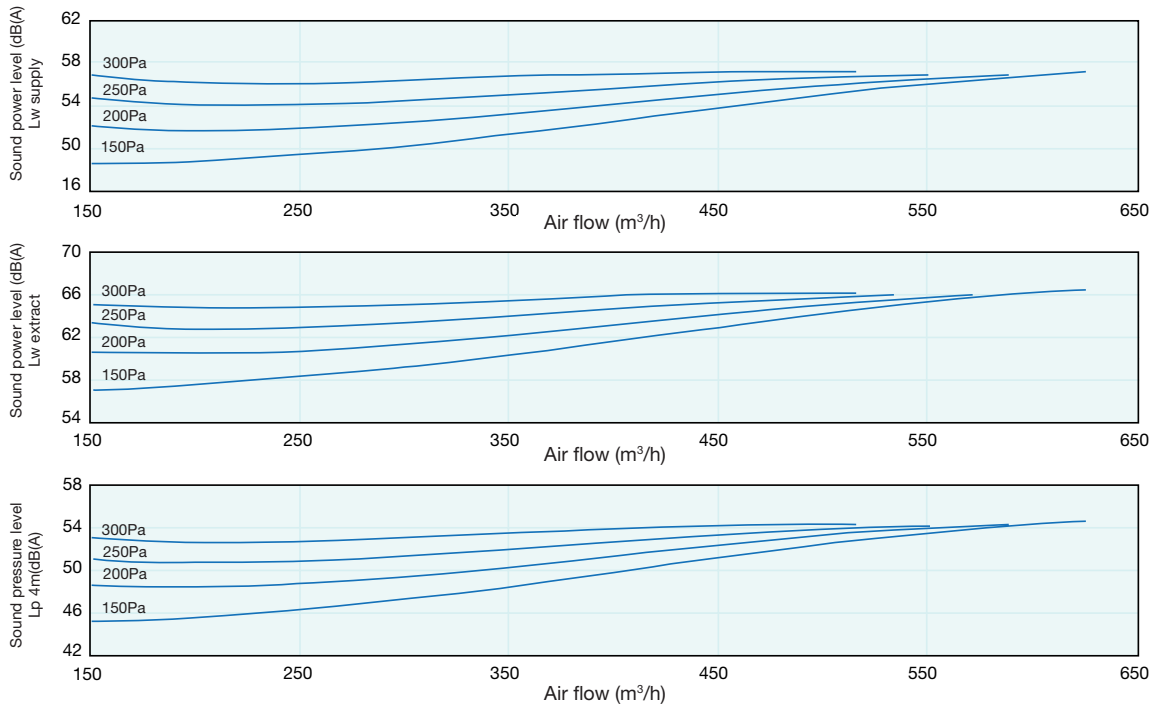

VORT NRG 1500 ECR - ECR EH

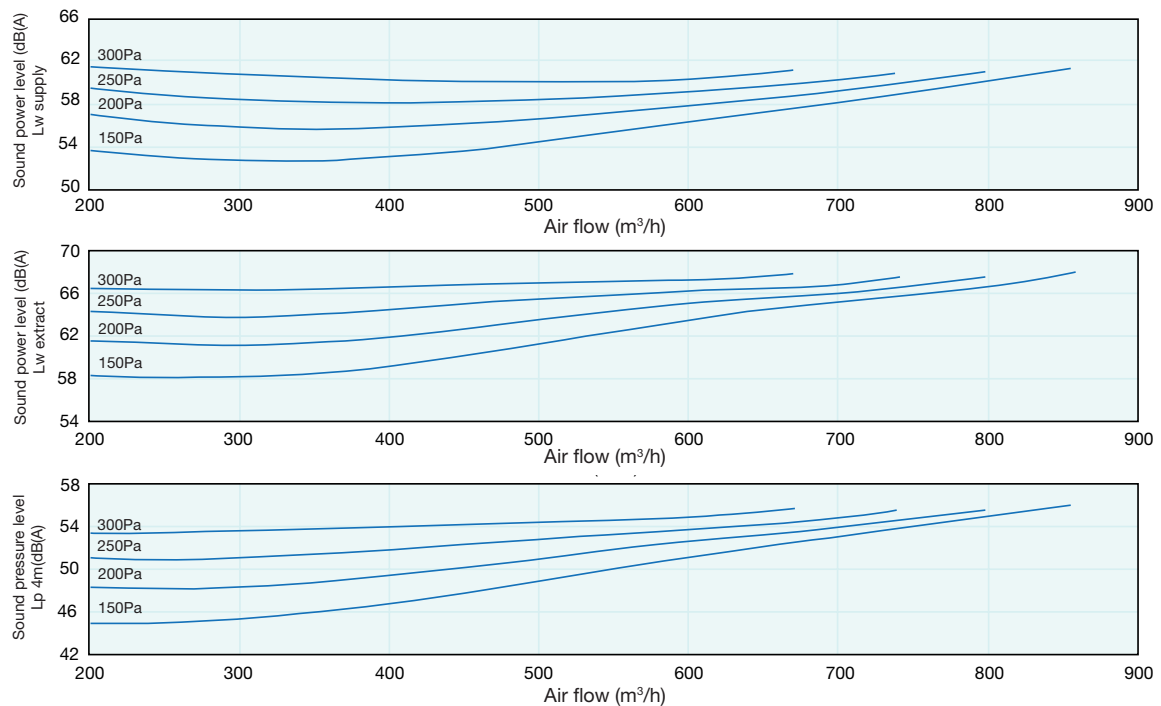

NOISE EMISSIONS

VORT NRG 800 ECR - ECR EH

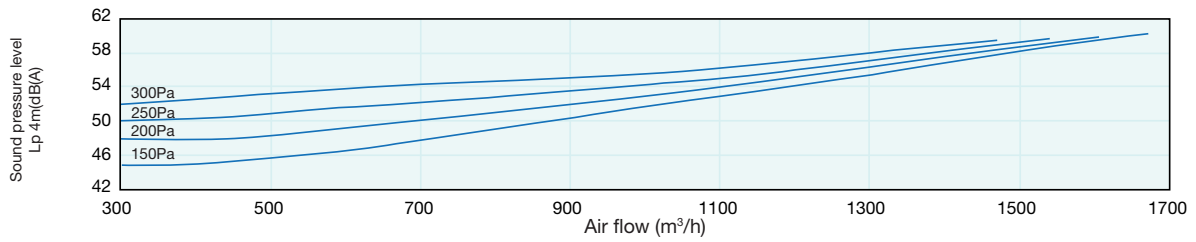
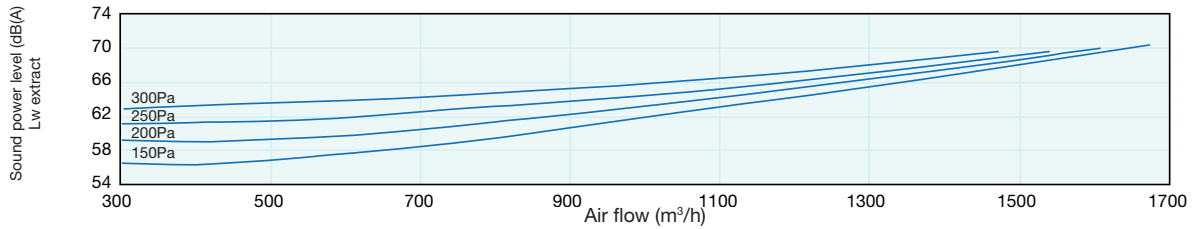
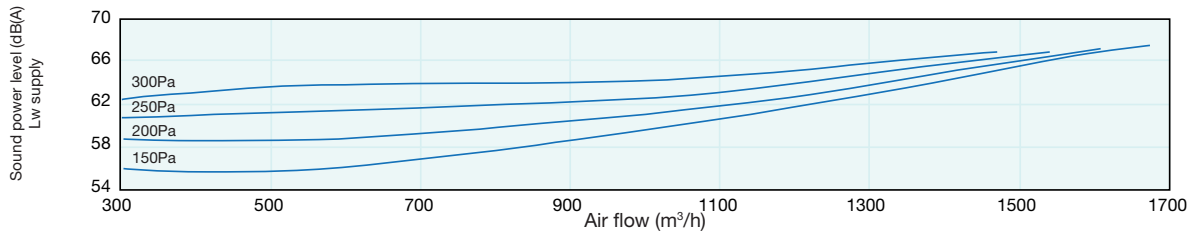

VORT NRG 2000 ECR - ECR EH

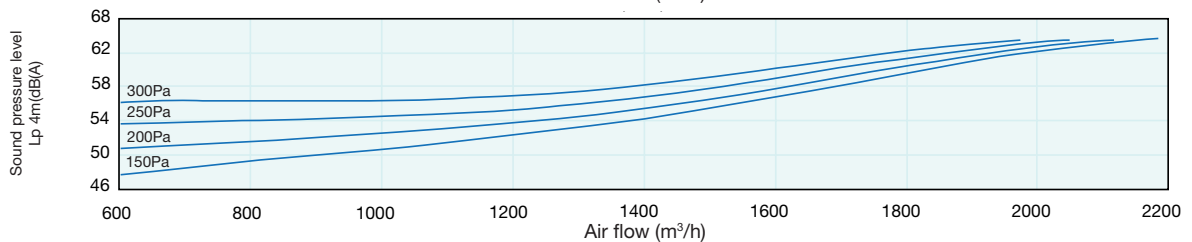
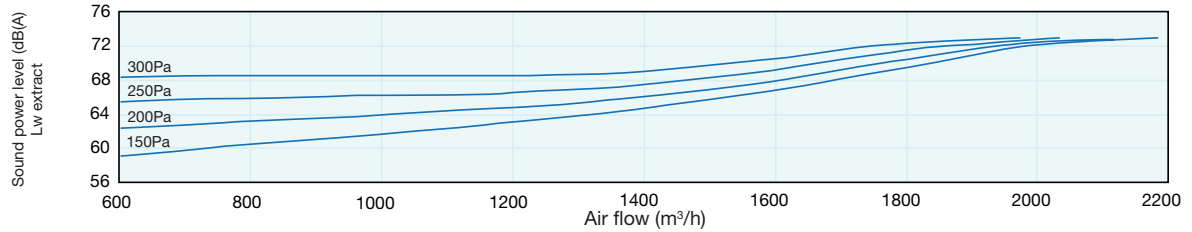
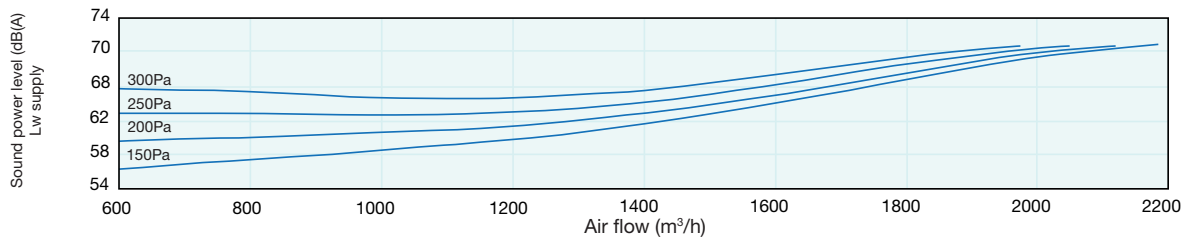



VORT NRG ECR RANGE

Heat recovery units equipped with rotary heat exchangers characterized by high levels of heat exchange efficiency, top performances and low consumptions

NOISE EMISSIONS

VORT NRG 2500 ECR - ECR EH

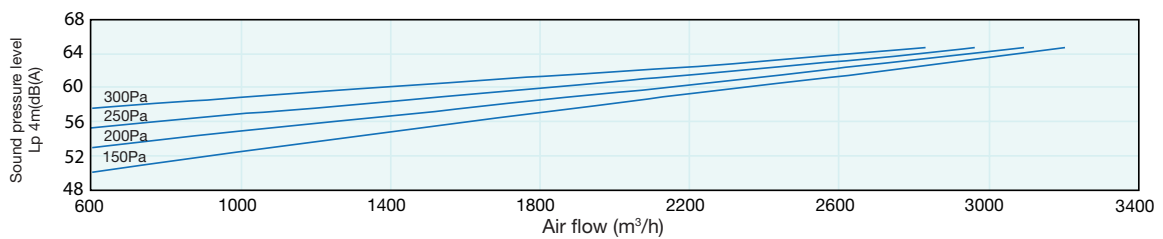
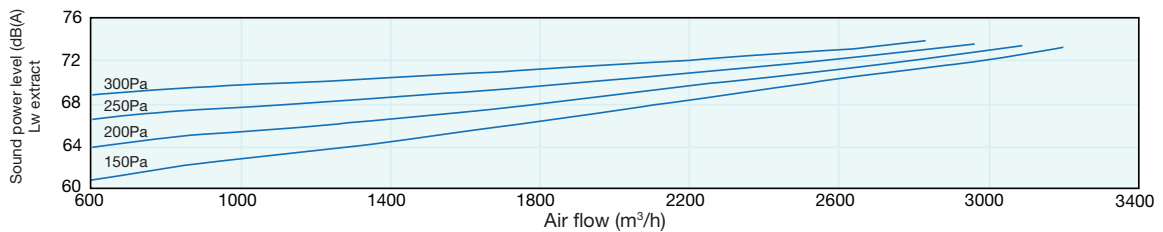
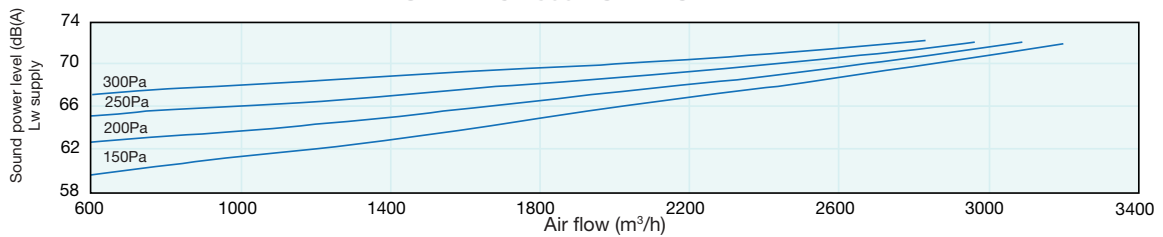

VORT NRG 3000 ECR - ECR EH

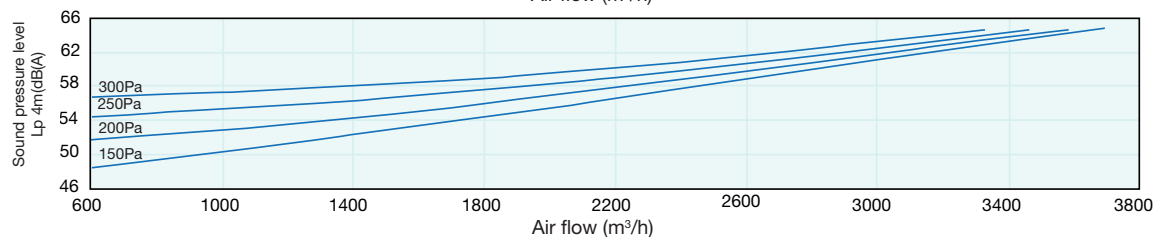
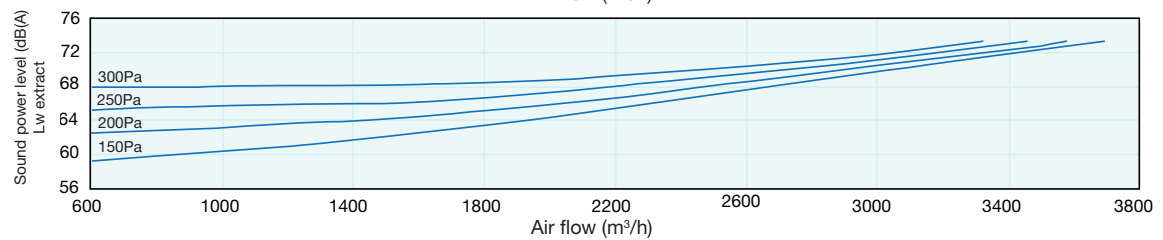
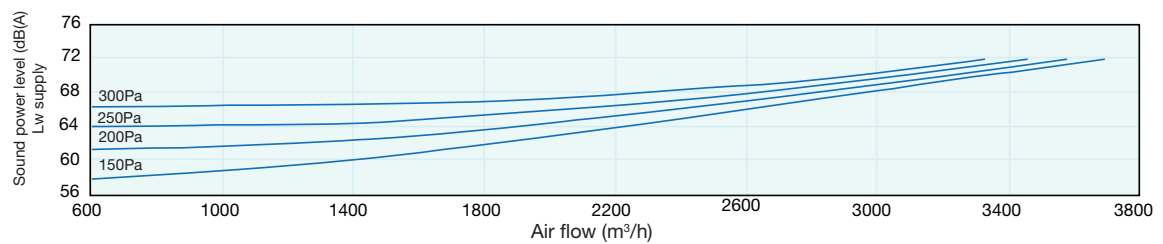

ACCESSORIES

Description	Code	Product
POTI NRG Speed control potentiometer for one or both fans	21039	VORT NRG ECR all models
TOUCH LCD CP Control panel with LCD display touch	21025	VORT NRG ECR EH all models
NRG EC 200 FPD Motorized round damper rated IPX4 for protection against frost, Ø 200 mm	21055	VORT NRG ECR - ECR EH 600
NRG EC 250 FPD Motorized round damper rated IPX4 for protection against frost, Ø 250 mm	21056	VORT NRG ECR - ECR EH 800
NRG EC 315 FPD Motorized round damper rated IPX4 for protection against frost, Ø 315 mm	21057	VORT NRG ECR - ECR EH 1500
NRG EC 355 FPD Motorized round damper rated IPX4 for protection against frost, Ø 355 mm	21058	VORT NRG ECR - ECR EH 2000
NRG EC 400 FPD Motorized round damper rated IPX4 for protection against frost, Ø 400 mm	21059	VORT NRG ECR - ECR EH 2500
NRG EC 450 FPD Motorized round damper rated IPX4 for protection against frost, Ø 450 mm	21080	VORT NRG ECR - ECR EH 3000

Cod. 5.170.084.997

01/16

Vortice Elettrosociali S.p.A
Strada Cerca, 2
Frazione di Zoate
20067 Tribiano (Milano)
Tel. (+39) 02 906991
Fax (+39) 02 90699314
Italia
www.vortice.com
export@vortice-italy.com

Vortice France
15-33, Rue Le Corbusier
CS 30007
94046 Créteil Cedex
Tél. (+33) 1.55.12.50.00
Fax (+33) 1.55.12.50.01
France
www.vortice-france.com
contact@vortice-france.com

Vortice Limited
Beeches House-Eastern Avenue
Burton on Trent
DE13 0BB
Tel. (+44) 1283-49.29.49
Fax (+44) 1283-54.41.21
United Kingdom
www.vortice.ltd.uk
sales@vortice.ltd.uk

